



GRID
MODERNIZATION
LABORATORY
CONSORTIUM
U.S. Department of Energy

Grid Architecture Guidance Specification for FAST-DERMS

V1.0

April 2021

JD Taft
JP Ogle

PNNL-31172

DISCLAIMER

This report was prepared as an account of work sponsored by an agency of the United States Government. Neither the United States Government nor any agency thereof, nor Battelle Memorial Institute, nor any of their employees, makes **any warranty, express or implied, or assumes any legal liability or responsibility for the accuracy, completeness, or usefulness of any information, apparatus, product, or process disclosed, or represents that its use would not infringe privately owned rights.** Reference herein to any specific commercial product, process, or service by trade name, trademark, manufacturer, or otherwise does not necessarily constitute or imply its endorsement, recommendation, or favoring by the United States Government or any agency thereof, or Battelle Memorial Institute. The views and opinions of authors expressed herein do not necessarily state or reflect those of the United States Government or any agency thereof.

PACIFIC NORTHWEST NATIONAL LABORATORY
operated by
BATTELLE
for the
UNITED STATES DEPARTMENT OF ENERGY
under Contract DE-AC05-76RL01830

Printed in the United States of America

Available to DOE and DOE contractors from the
Office of Scientific and Technical Information,
P.O. Box 62, Oak Ridge, TN 37831-0062;
ph: (865) 576-8401
fax: (865) 576-5728
email: reports@adonis.osti.gov

Available to the public from the National Technical Information Service
5301 Shawnee Rd., Alexandria, VA 22312
ph: (800) 553-NTIS (6847)
email: orders@ntis.gov <<http://www.ntis.gov/about/form.aspx>>
Online ordering: <http://www.ntis.gov>



This document was printed on recycled paper.

(8/2010)

Grid Architecture Guidance Specification for FAST-DERMS V1.0

JD Taft¹
JP Ogle¹

April 2021

¹ Pacific Northwest National Laboratory

Summary

This document provides grid architecture guidance to support the Grid Modernization Laboratory Consortium (GMLC) Federated Architecture for Secure and Transactive Distributed Energy Resource Management Solution (FAST-DERMS) project. The FAST-DERMS project seeks to develop an architecture and reference implementation solution that enables the provision of reliable, resilient, and secure transmission and distribution (T&D) grid services through the scalable aggregation and near-real-time management of utility-scale and small-scale distributed energy resources (DERs).

The U.S. electricity delivery system is changing in function and structure. Legacy structure and, in some cases, organically emerging structures present constraints on new grid functions and intrinsic characteristics. A DER management solution architecture must consider present grid structure and plausible futures (while not attempting to predict a specific future). Key issues for the FAST DERMS architecture are:

- coordination and communication
- distributed intelligence and distributed operation
- industry structure.

Prior work in the GMLC Grid Architecture project examined the limitations of the existing grid relative to the desired qualities of a modernized grid and specified new grid structures to enable the realization of those desired qualities. As part of that work, a reference architecture was developed to illustrate structural approaches to managing grids with high penetration of DER, distribution automation, and/or storage. This document summarizes key grid architecture level specifications from that reference architecture to guide the FAST-DERMS architecture development.

Acronyms and Abbreviations

BPS	bulk power system
BTM	behind the meter
DA	distribution automation
DER	distributed energy resource
DG	distributed generation
DO	distribution operator
DR	demand response
DS	distributed storage
DSN	distribution storage network
DSO	distribution system operator
D-STATCOM	distribution static synchronous compensator
EE	energy efficiency
E-R	entity-relationship
ES	energy storage
ESO	energy services organization (DER aggregators, remote building energy managers, etc.)
EV	electric vehicle
FAN	field area network
FAST DERMS	Federated Architecture for Secure and Transactive Distributed Energy Resource Management Solutions
FCAPS	fault, configuration, administration, performance, security
FLISR	fault location, isolation, and service restoration
ICT	information and communication technology
ISO	independent system operator
LEN	logical energy network
NAN	neighborhood area network
NERC	North American Electric Reliability Corporation
NWA	non-wires alternative(s)
PEV	plug-in electric vehicle
PFC	power flow controller
PV	photovoltaic; e.g., solar electric generation
RTO	regional transmission organization
T/D	transmission/distribution
TEDS	transducer electronic data sheet(s)
TSO	transmission system operator
UPFC	universal power flow controller

UPQC	universal power quality conditioner
V/VAR	Volt(s) / Volt ampere(s) reactive
WAN	wide area network

Contents

Summary	ii
Acronyms and Abbreviations.....	iii
1.0 Introduction.....	1
1.1 Problem Domain Reference Model.....	1
1.2 Key Emerging Trends and Systemic Issues	1
1.3 Scenarios and Point of View	1
1.4 Business Context, Entities, and Relationships	2
1.5 Regulatory/Public Policy Context.....	2
2.0 Grid Architecture	3
2.1 Objectives.....	3
2.2 Core Grid Architecture Principles.....	3
2.3 General Architecture Principles	4
2.4 Core Grid Architectural Concepts.....	5
3.0 Grid Architecture Specifications	8
3.1 Key Components	8
3.2 Baseline Entity Relationship Model.....	8
3.3 Single-Structure Views	10
3.3.1 Specification 1: Distribution Role Evolution	10
3.3.2 Specification 2: Regulation via Power Electronics in Distribution Grids.....	13
3.3.3 Specification 3: Distribution Layer Structure and Observability Platform.....	16
3.3.4 Specification 4: Laminar Coordination Networks.....	19
3.3.5 Specification 5: Storage.....	24
3.3.6 Specification 6: Logical Energy Networks and Distribution Virtualization	24
3.3.7 Specification 7: Fault Location, Isolation, and Service Restoration (FLISR).....	28
3.3.8 Specification 8: Distributed Intelligence Platform.....	29
3.3.9 Specification 9: Cybersecurity Structures	31
3.3.10 Specification 10: Distribution Automation and Distributed Control	33
3.3.11 Specification 11: Communication Structures.....	45
3.3.12 Specification 12: Data Flow Models.....	48
4.0 Composite Structure Views	54

Figures

- 1. Existing Grid E-R Structure Diagram.....9
- 2. Existing Grid Stack Model.....10
- 3. Total DSO/TSO Industry Structure Model11
- 4. Multi-DSO DER Telemetry Flows12
- 5. Internal Hardware Structure of a Power Flow Controller.....14
- 6. Two General Configurations of Power Flow Controllers.....14
- 7. Distribution Feeder Segmentation15
- 8. Simple Three-Bus Meshed Distribution Network16
- 9. Siloed System Structure Results in System Brittleness17
- 10. Sensor Communications Layer Structure18
- 11. Sensor/Communications Infrastructure Layer Functions19
- 12. Laminar Coordination Framework Structural Elements.....20
- 13. Laminar Coordination Domain Structure21
- 14. Example Laminar Network.....22
- 15. Building-to-Grid Interface Models23
- 16. Example Feeder LEN Structure25
- 17. Grid Stack Model Diagram with LENs27
- 18. Electricity Grid Distributed Intelligence Platform.....30
- 19. Laminar Coordination of Distributed Generation.....34
- 20. Laminar Coordination of Inverters35
- 21. Laminar Control of EV Charging Networks.....36
- 22. Layered Control of Heterogeneous DER Networks37
- 23. Meshed Distribution Feeder with High Level of DA38
- 24. Basic Layered, Logical Structure for Control and Coordination of High DA/DER Feeders39
- 25. LEN View of Lower Layer of Laminar Coordination40
- 26. Laminar Decomposition of Stationary Charging Infrastructure for PEVs41
- 27. Autonomous EV Dynamic Groups Joining LENs to Mitigate wind/PV Curtailment.....43
- 28. Layered Decomposition Applied to Synthesis of LENs and Aggregated EV Resources across Multiple Domains44
- 29. Three-Tier Communications Structure with Substation Aggregation47
- 30. Data Flows Overlaid on “As Is” Grid Entities.....49
- 31. Data Flows for High-DER Deployments.....51
- 32. Coordination and Collaboration Data Flows52
- 33. New LEN/Laminar/DSO-Based Grid Structure E-R Diagram.....54
- 34. Composite View of Grid Structure Coordination, Control, and Communication56

1.0 Introduction

This document provides grid architecture guidance to support the Grid Modernization Laboratory Consortium (GMLC) Federated Architecture for Secure and Transactive Distributed Energy Resource Management Solution (FAST-DERMS) project. The FAST-DERMS project seeks to develop an architecture and reference implementation solution that enables the provision of reliable, resilient, and secure transmission and distribution (T&D) grid services through the scalable aggregation and near-real-time management of utility-scale and small-scale distributed energy resources (DERs).

In this document key architectural principles and objectives are defined. A set of core architectural concepts that are relevant to the problem domain of FAST-DERMS are presented. Finally, a set of architectural specifications associated with grid architecture are defined. These grid architecture specifications provide structures at a top-level grid viewpoint. They inform the underlying system architecture to ensure that the complex set of components and relationships form a cohesive whole at the grid level.

The FAST-DERMS scope is a subset of the overall grid architecture. As such some specification may not be addressed by FAST-DERMS. However, by examining the full specification from the grid architecture viewpoint presented, the architects of FAST-DERMS or other grid solutions can better understand the relationships across the components and interfaces that make up the grid architecture as it relates to high DER and storage environments.

1.1 Problem Domain Reference Model

The problem domain is the existing electricity grid, and while that term is broad, the issue has become nearly ubiquitous in recent years and so has application across regions and industry structures. The problem domain is described in detail in *Problem Domain Reference Model – FAST DERMS v3.pdf*².

1.2 Key Emerging Trends and Systemic Issues

The document *Emerging Trends and Systemic Issues Influencing Today's U.S. Electric Grid, EmergingTrends_SystemicIssues_Grid_v4.0.pdf*², contains the list of emerging U.S. utility trends used as input to the grid architecture development.

1.3 Scenarios and Point of View

The key scenarios for this architecture guidance are the following:

- high penetration of (meaning more than 50% of feeder power sourced from) distributed energy resources (DERs)
- high levels of deployed distribution automation (20% or more of distribution feeders have advanced sensing, measurement, protection, and control) with a subset of high penetration of power electronics for grid control functions (flow control, regulation, stabilization, and synchronization)

² Available at https://gridarchitecture.pnnl.gov/media/zip/High_DER_DA_Sto_Reference_Architecture_package.zip.

- high penetration of grid energy storage, with two subsets: high penetration of grid-embedded storage (owned/operated by electric utilities) and high penetration of behind-the-meter (BTM) storage
- high penetration (more than 50% of vehicles in use) of electric vehicles and vehicle chargers
- buildings and microgrids acting as grid resources (providing grid services).

The point of view in this reference model is systemic across multiple industry structures and regions.

1.4 Business Context, Entities, and Relationships

A wide array of entities is involved in the U.S. electric power system. A list of entities and their standard definitions can be found in the spreadsheet *Entities.Definitions.01.09.2019.xlsx*².

The U.S. electric utility industry has a complex set of structures that vary regionally because there are different types of utilities (investor-owned utilities, co-ops and municipals, power marketing authorities, generation and transmission cooperatives, vertically integrated utilities, etc.), as well as system operators, balancing authorities, reliability coordinators, and the like). Refer to the following industry structure models²:

- California (focused on CA ISO service area): *CA focused industry structure model ER.vsd*
- New York: *NY Industry Structure Diagram_v1.2.vsd* and *NY Industry Structure Diagram_v1.2.xlsx*
- Texas with focus on Electric Reliability Company of Texas (ERCOT) service area: *ERCOT Industry Structure Diagram_v1.vsd*, *ERCOT Industry Structure Diagram_v1.xlsx* and *ERCOT Market Control_v0.1.vsd*.
- Pacific Northwest: *PNW Industry Structure Diagram_v1.vsd* and *PNW Industry Structure Diagram_v1.xlsx*.

1.5 Regulatory/Public Policy Context

Regulations vary widely for distribution, since most distribution issues are regulated at the state level. Some aspects of DER may fall under jurisdiction of the Federal Energy Regulatory Commission, especially those related to sale or resale of energy or generation capacity. Many states have public policies and regulations regarding renewable resource portfolios and goals that drive adoption of DER and especially wind and solar photovoltaic (PV) distributed generation (DG). One state (New York) has declared that distribution utilities will have distribution-level DER markets, primarily for the purpose of distribution capacity management by non-wires alternatives, but with other goals as well. In some cases, this must lead to two markets for DER, and competing uses for the same assets. In those cases, resolution of control or coordination is an important issue.

2.0 Grid Architecture

2.1 Objectives

As described in the reference document *Grid Architecture 2*,³ modernized grids must support seven system qualities, namely delivery, conservation, preservation, protection, adaptivity, enablement, and merit. The qualities of delivery, adaptivity, and enablement are especially relevant to this reference grid architecture viewpoint. Specifically, the overall objective for this reference architecture is to show how to modify existing grid structure and specify new grid structure, as appropriate, to enable the grid to accommodate and make use of DER.

The objectives for the grid reference architecture are to indicate structural approaches that will

1. Provide industry structure models that relieve constraints on the use of DER and facilitate the increasing penetration of DER and enable its use for customer and system benefit.
2. Accommodate DER that may exist in dynamic, heterogeneous mixtures that vary across a system with multiple models of DER use, ownership, and operation.
3. Enable improved electric system reliability and resilience by automating grid operations and responses.
4. Enable creative uses of and access to DER assets and enable new business models for the grid.
5. Redefine bulk power system and distribution system relationships to improve system operation and resilience.

The structural changes should be limited as much as is feasible and should be implementable in incremental or proportional fashion without the need to disable large portions of the grid or to disable any part for significant time periods. To the extent that the grid structural changes can enable, support, or provide the potential to improve recovery after some failure, they should also do so.

2.2 Core Grid Architecture Principles

1. For operational purposes, DER includes DG, demand response (DR), and distributed storage (DS), but not energy efficiency. Microgrids count as DER.
2. From the grid's point of view, buildings and microgrids look the same. Each may be capable of supplying services to the grid.
3. Standardize interface types between the grid and edge-connected devices and systems and keep the number of such interface types as small as possible.
4. Provide flexibility and granularity in grid structures for DER and distribution automation (DA) (scalability for DER penetration, reconfigurability of the grid for DA).
5. DER types may be intermingled at any scale; mixes may be dynamic and may vary across a single distribution system. Accommodate dynamic DER mixes, groupings, and grid connections.

³ JD Taft, *Grid Architecture 2*, PNL-24044 2, January 2016. Available online: <https://gridarchitecture.pnnl.gov/media/white-papers/GridArchitecture2final.pdf>.

6. Grid structure should enable DER to provide multiple benefits to the grid, if it can, to the extent practical.
7. For utility-owned DER, grid structure should support flexible placement.
8. DER should be able to work with a bulk power system or distribution system or more local operational control groupings as desired by owners, users, and operators.
9. Coordination structure must be able to merge electrical physics with economic or other coordination mechanisms (i.e., do not decouple markets from physical systems).

2.3 General Architecture Principles

1. A good architecture is one that meets the needs of the stakeholders (especially the users) to their satisfaction, does not violate established principles of system architecture, and takes into account the qualities and properties the stakeholders require.
2. Good architectures have conceptual integrity (adhering to a set of core principles, clean of unnecessary complexities or “exceptions,” similar problems are solved in similar ways).
3. Conceptual integrity is best achieved by a small cohesive team of like-minded architects. Architecture should be the product of a single architect or small team with an identified leader.
4. Essential functionality drives complexity, not architectural “elegance.”
5. Architectural structures should have formal bases, where possible, to minimize ad hoc configurations with unknown properties.
6. Architecture should not depend on a particular commercial product or tool.
7. Architecture should produce enforceable key constraints.
8. The architect must be cognizant of the global system when optimizing subsystems.
9. Stakeholders should be involved in the process as much as possible, giving frequent and honest feedback on all aspects of the system architecture.
10. Each component should be responsible for only a specific feature, functionality, or aggregation of cohesive functionality. Components should be coupled only through explicit structure, avoiding hidden coupling where possible.
11. Reference grid architectures should inform interfaces.
12. The system architect is not a generalist, but rather a specialist in managing complexity.

2.4 Core Grid Architectural Concepts

In addition to the guiding architectural principles, a set of core concepts listed here inform the architecture specifications that are discussed later.

Situational awareness – The need for situational awareness is fundamental. This involves more than just grid power state. This work uses the concept of extended grid state, as defined in the work done in the U.S. DOE Grid Modernization Initiative Sensing and Measurement Strategy project.⁴

Ultra-large scale normal failures approach – Applying ultra-large scale system theory⁵ to the grid leads to the view that faults and failures must be treated as normal events rather than exceptions. This includes failures in DER and in communications to DERs as well as general grid failures. Examples include intermittent communication link failures, inadequate software maintenance and faulty upgrades, noisy and/or missing measurements, and any number of other failures that plague large, complex systems.

Flexibility, extensibility, and agility – These reflect the ability of a system (in this case, the grid) to make (usually automatic) adjustments to alleviate grid stresses. This can include traditional energy resource flexibility, and increasingly, energy resource flexibility afforded by the use of DER, including net load flexibility. It also includes structural flexibility, such as automated capability for fault isolation and circuit reconfiguration. It also includes the ability to change or add functions and behaviors as new circumstances warrant.

Extensibility, the ability to add functionality without major restructuring, is a key to future-proofing investments and is a legitimate focus for grid architecture. The driving forces in the extensibility case come from at least one of the following:

- changing customer expectations
- availability of new technology
- new legislative or regulatory mandates.

Structural extensibility is a means to address such trends, by providing the foundation for agility in implementing new capabilities. Agility refers to the speed with which either flexibility or extensibility can be exercised.

Decentralized, distributed, and centralized systems – A decentralized system is one in which the elements are separate (usually geographically dispersed, but not always) and act independently, with perhaps some small amount of supervision to provide set points, etc. A distributed system is a decentralized system in which the elements cooperate to solve a common problem. This implies some form of communication among the decentralized elements. A centralized system is one in which all the computing, logic, control, data analysis, etc. is performed at a single element. A centralized system is a degenerate form of distributed architecture, and a distributed system may have a central element that participates in the overall processes, the latter being sometimes characterized as a hybrid of central and distributed architectures.

⁴ GMLC Sensing and Measurement Extended Grid State Task Team, *Extended Grid State Definition Document*, PNNL-SA-141027. Available online: https://gridarchitecture.pnnl.gov/media/white-papers/Extended_Grid_State_Definition_v3.3_GMLCFormat_final.pdf.

⁵ Mark Klein, Linda Northrop, et al., *Ultra-Large-Scale Systems*, Software Engineering Institute, Carnegie-Mellon University, 2006. Available online: https://resources.sei.cmu.edu/asset_files/Book/2006_014_001_635801.pdf.

The distributed architecture concept is applied to the grid in several ways. The most obvious is for coordination and control, but also applies to generation and storage and to data management and analytics (intelligence). Note that markets are always distributed systems, even when the market clearing mechanism is centralized, as is the case with organized, wholesale electricity markets.

Buffering – Most complex systems have buffers of one kind or another. For example, communications systems use jitter buffers to even out the flow of data bits from uneven sources. Logistics systems use buffers: they are called warehouses. Water and gas systems use buffers: they are called storage tanks. In each case, the buffer serves to even out flow variations. Acting as a kind of shock absorber, by providing springiness or sponginess, they cushion a system against stresses that arise from volatility of sources. Power grids (especially at the distribution level) lack buffering, due in part to limitations on technology, and for the distribution case, because it was not needed in the 20th Century.

Grid energy storage as a core grid component – Grid energy storage is available in a variety of forms with a range of values of the externally visible properties. While some models for the use of grid energy storage are based on the concepts of value stacking of multiple functions and monetization of storage by bidding grid services into wholesale markets, there are a number of models for grid energy storage that serve to improve grid operations. When applied at the distribution level, decoupling is bidirectional, meaning that volatility arising at the bulk power system (BPS) level can be decoupled from the distribution system and loads; volatility at the distribution edge arising from DER can be decoupled from the BPS. Both types of decoupling offer operational advantages. Generally, the use of grid energy storage at the electricity distribution level as a core grid component relates to a range of operational functions and BPS grid services. The Federated Architecture for Secure and Transactive Distributed Energy Resource Management Solutions (FAST DERMS) is not responsible for managing embedded core infrastructure storage but must be coordinated in such a way as to not conflict with its operational functions.

These operational functions include

- regulation and stabilization
- outage ride-through
- black-start support
- volatility management
- distribution flow management support
- system integrity remediation
- mitigating the need for secondary load control
- generator black start
- defense against edge-based volatility attacks
- system agility improvement.

Distributed and mixed entity coordination/control – Control of DER, especially grid connected inverters, must fit into a structure that allows for mixtures of DER, for control of DER by various entities besides the distribution utility, and for interpenetration of DER types and entities (e.g., multiple DER aggregators operating in overlapping areas down to the distribution circuit secondary level), as well as direct control by the distribution utility. Communication with the DER elements for the purpose of control may be through utility communication networks or through telecommunications service providers and may include the internet. All these modes of communication and control may coexist in a single utility service area. In addition to control via an external entity, control may be performed autonomously

by any particular DER element, or groups of DER elements may associate and operate as coordinated DER networks, either under supervision by an external entity or as an autonomous system. Distribution automation systems may operate in similar autonomous unit or coordinated autonomous group modes.

Regular repeating structures in control and coordination – To manage complexity, coordination and control structure must be assembled from defined building blocks that can be used at various scales to compose complete structures (architectures) for coordination and control with sufficient regularity and interface definition to enable both simple DER integration and self-assembly of DER and DA networks.

Sensing/measurement infrastructure layer – Sensing and communications for the distribution grid must be structured as an infrastructure layer rather than a set of application silos.⁶

⁶ J Taft and P De Martini, *Sensing and Measurement Architecture for Grid Modernization*, PNNL-25249, February 2016. Available online: <https://gridarchitecture.pnnl.gov/media/advanced/Sensor%20Networks%20for%20Electric%20Power%20Systems.pdf>.

3.0 Grid Architecture Specifications

The architectural views are presented in terms of (black box) components, structures, and externally visible characteristics.⁷ These views are not designs, but can be used as precursors to such.

3.1 Key Components

Key component classes are defined in the Component Class Models². They include

Grid Architecture Component Class Specification – Storage v0.2

Grid Architecture Component Class Specification – Microgrid v0.1

Grid Architecture Component Class Specification – Digital Communications Network v0.1

Grid Architecture Component Class Specification – Grid Sensor v0.2

Grid Architecture Component Class Specification – Inverter

Grid Architecture Component Class Specification – Load

Grid Architecture Component Class Specification – Power Flow Controller

Grid Architecture Component Class Specification – Solar PV

Grid Architecture Component Class Specification – Electric Vehicle

Grid Architecture Component Class Specification – Electric Vehicle Charger

This set is **not intended to be an exhaustive list of component types used in electric power systems**. Rather, it is intended to provide definitions of key component types (especially those that are new or are just emerging in importance in electric power delivery systems). Many of these newer component types have multiple or ambiguous definitions; the Component Class Model documents provide clarity on the definitions used in this specification.

3.2 Baseline Entity Relationship Model

The diagram in Figure 1 is a baseline structural model for electric power systems, cast in the form of an entity relationship (E-R) diagram. This model includes distribution-connected generation, storage, and responsive loads (DR), collectively referred to here as edge resources. A number of organizational and individual entities are shown, although this is not intended to show all (for those, see the industry structure models and the entity list referred to in section 1.4). This diagram is a hybrid that includes entities and systems/devices. The standard electrical infrastructure is on the right-hand side in the vertical stack of blue boxes. Primary grid operational entities are shown in green. Nonutility entities are shown in gray and pink. Two substructures (microgrid and substation service area) are shown in white boxes.

This diagram represents the traditional electricity delivery system power flow model (from bulk generation through transmission and distribution to users), but includes DER in its typical present-day manifestation. While the proliferation of DER has begun to trigger structural and operational changes in some areas of the U.S., actual penetration has generally not caused utilities to move past the first stage of distribution grid evolution, as defined in the next-generation distribution-system platform (DSPx) three-

⁷ See <http://gridarchitecture.pnnl.gov/basic-terms-and-principles.aspx> for explanation of basic terms and concepts.

stage model.⁸ So, this schema is a useful “starting point” representation. The specifications below will describe a model reference grid architecture with a focus on DER, DA, and storage integration for electricity distribution systems. That architecture will provide the “ending point” representation.

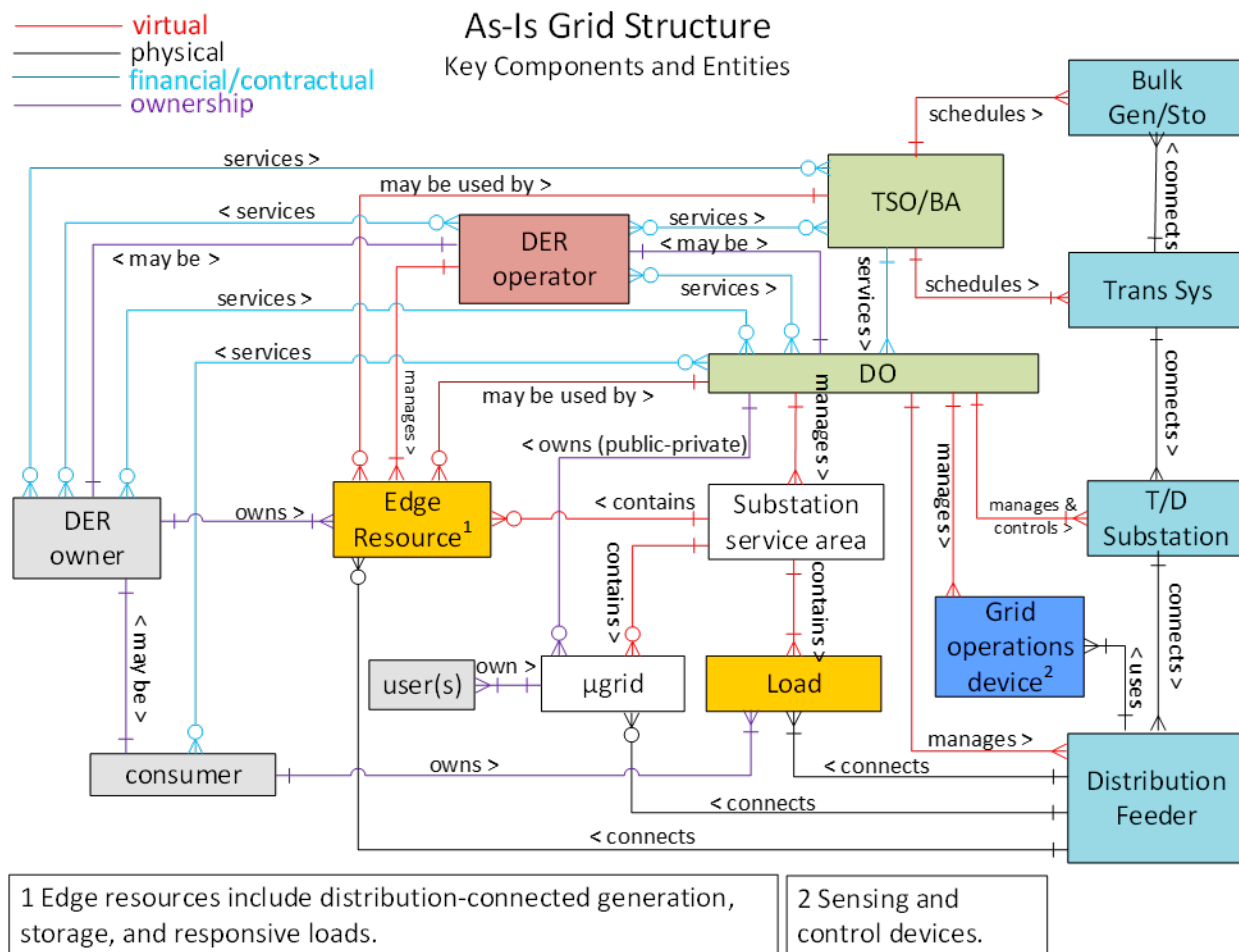

Figure 1. Existing Grid E-R Structure Diagram

The stack diagram in Figure 2 is an alternative representation of the same system. In this depiction, the grid is viewed as comprising two primary domains: the BPS domain and the distribution domain.⁹ This model emphasizes the similarities and differences in gross organization structure (not physical infrastructure); it will be used to enhance the partial homology¹⁰ that exists now to derive a new structure that enables DER/storage integration and DA. Note that, while DER aggregators as an entity class are declining, there is still a DER Operator role, which may be filled in various ways.

⁸ P De Martini, et al., Modern Distribution Grid Decision Guide Vol III, July 28, 2017. See Figure 4 in this document. Available online: <https://gridarchitecture.pnnl.gov/modern-grid-distribution-project.aspx>.

⁹ See Visio file *high DER DA Sto arch drawings v1.1.vsd* referenced in for extended stack models with nonutility domains (buildings, microgrids, DER) available at https://gridarchitecture.pnnl.gov/media/zip/High_DER_DA_Sto_Reference_Architecture_package.zip.

¹⁰ In the biological sense of structural correspondence.

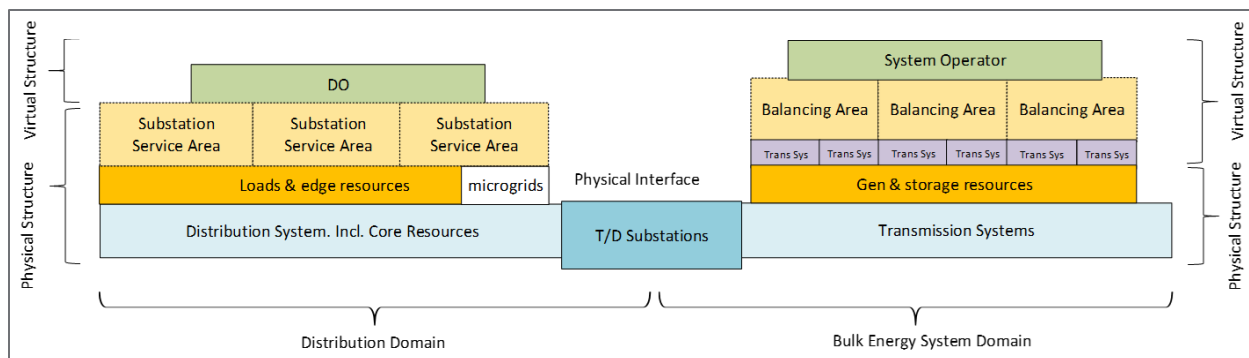

Figure 2. Existing Grid Stack Model

The two representations in Figure 1 and Figure 2 are a baseline from which some aspects of the high-DER/DA reference architecture representations will be described, especially as regards electricity distribution.

3.3 Single-Structure Views

This section provides a number of single-structure specifications. Each focuses on a specific structure class from the standard set: electric infrastructure, industry structure, information and communications technology (ICT) superstructure, control structure, converged networks, and regulatory structure. In this specification, regulatory structure is treated only as a constraint.

3.3.1 Specification 1: Distribution Role Evolution

The transmission/distribution coordination architecture is currently largely ad hoc, but going forward can be structured as shown in Figure 3. The purpose of this structure is to provide a clean interface and separation of roles and responsibilities for distribution operators (DOs) and transmission system operators (TSOs). This enables the TSO to use distribution-connected assets (i.e., DER) for grid resilience and operational flexibility purposes without interfering with distribution operations or distribution system reliability. This structure derives from layered decomposition considerations and resolves issues of scalability, tier bypassing, and hidden coupling while limiting the exposure of the TSO to cyber vulnerabilities, as compared to flatter structures. Note that present-day bulk-power/distribution systems do not have DSOs, so tier bypassing and coordination gapping can and do occur. Where these exist, they are structural constraints until they can be changed.

At the system architectural level, the absence of distribution system operators (DSO) presents the issue of how to integrate FAST DERMS. Allowing FAST DERMS to bypass the distribution operator (DO) to connect to wholesale electricity markets would compound the structural problem that already exists in some places. Employing an architectural constraint that prevents FAST DERMS from bypassing the DO tier will position it for the eventual total DSO/TSO grid model.¹¹

¹¹ Most jurisdictions will go through a hybrid phase before reaching the total DSO model, if they ever do. This presents some complexity in arranging the FAST DERMS architecture to handle the present day and multiple plausible futures.

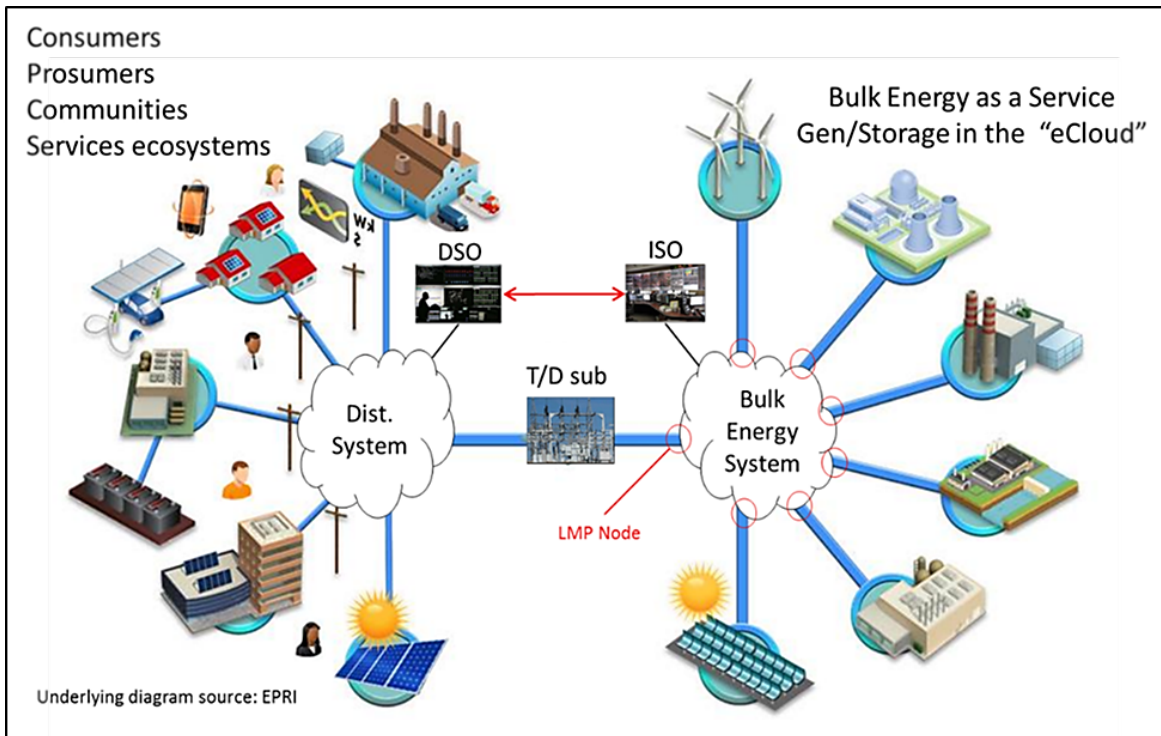

Figure 3. Total DSO/TSO Industry Structure Model

Note that from the perspective of the distribution operator, a BPS looks like a resource the DSO can manage in addition to its own DERs. It provides a clean interface where energy and services can be exchanged. This is a fundamental change from traditional BPS structure and operational models but is necessitated by changes happening at the distribution level. A significant and useful consequence of this model is that the DO handles all information exchange at the interface and does not have to supply detailed internal state information to the TSO. It resolves the issue of potential collisions over distribution reliability responsibility vs. tier-bypassing and reliability problems that arise from hidden couplings. This structure thereby benefits both the TSO and the DO.

This industry structure introduces a new interface: the DSO/TSO interface (indicated by the red, double-ended arrow in Figure 3). This interface is not the same as the system planning interface; it is operational in nature and may also include market functions if DER will participate in organized wholesale markets. This interface must support real-time operations on the same time scales as the bulk transmission generators and the TSO do. In this regard, this industry structure changes the TSO view of the distribution system from a passive, aggregated load to a combination of load and power/energy resources. The transmission/distribution (T/D) physical (electrical) interface becomes a combination of a load aggregation point and a generation tie point. The information flowing across this interface includes

- forecasts (load, available DER)
- bids and clearings
- dispatch requests
- aggregated distribution grid state, including grid services capacities
- grid services requests
- measurement and validation data.

This structure limits the number of new interfaces seen by the TSO to the number of distribution systems it serves, as opposed to the (potentially very much larger) number of DERs and energy services organizations (ESOs) that may want to participate in grid operations. This helps with scalability at the TSO level and limits the number of communication paths that the TSO must guard. Also, these paths have electric utilities at both ends, rather than having third parties on one end. In this structural context, the role of FAST DERMS and the nature of its interfaces is clear-cut and simple.

A consequence of this specification is that DER telemetry flows and dispatch instruction flows have a structure shown in Figure 4, where the lines indicate bidirectional data flow paths.

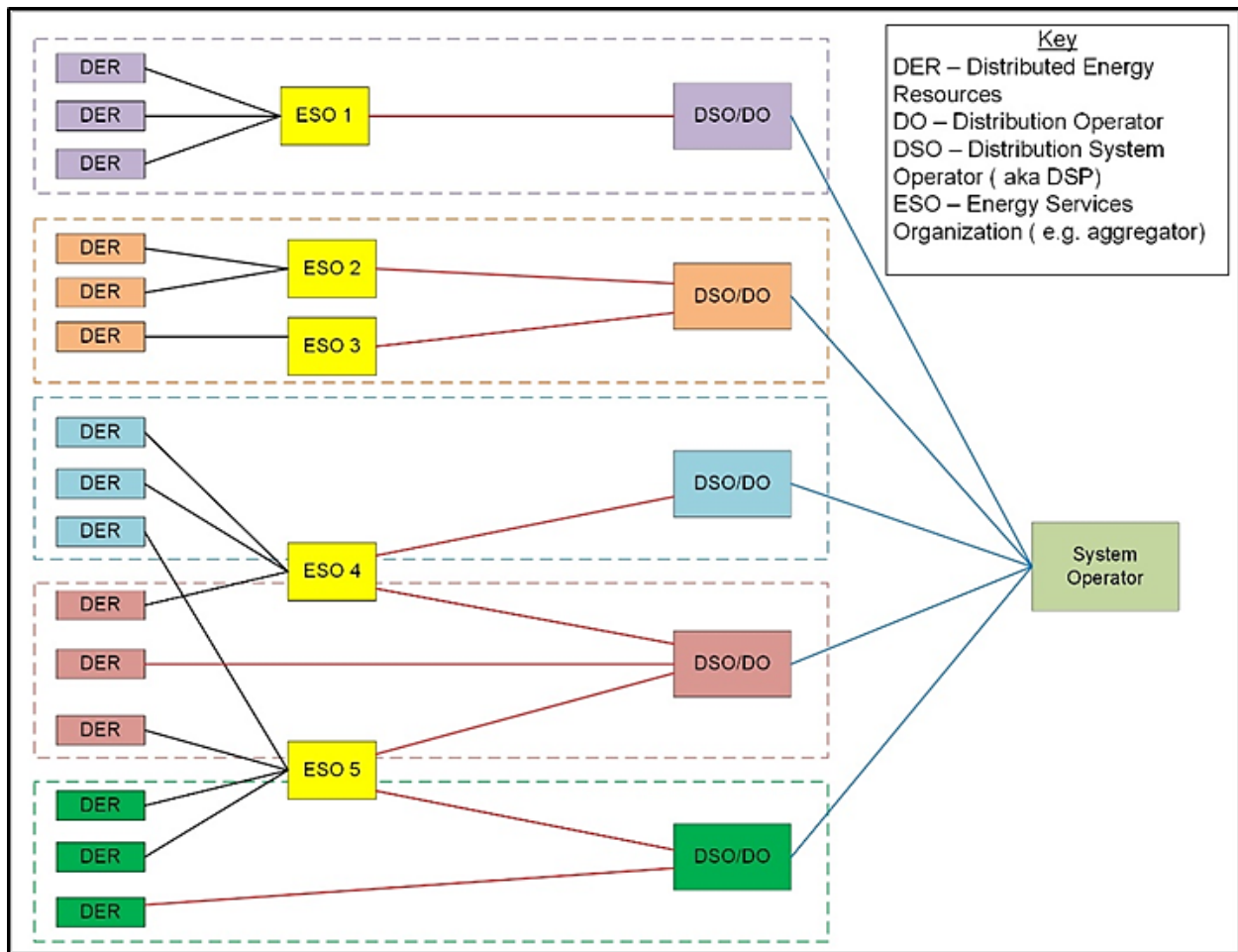

Figure 4. Multi-DSO DER Telemetry Flows

Note that no tier bypassing occurs in this structure. Also note that one TSO may deal with many DSOs (one for each distribution system that is connected to the TSO’s transmission systems), and each DSO may deal with many ESOs. ESOs may well operate in multiple distribution service areas, and so may deal with multiple DSOs and may interpenetrate each other’s “territories” in a given distribution service area. The number of DSOs is equal to the number of distribution systems involved. The number of ESOs is arbitrary.

The DSOs will have interfaces to ESOs and potentially to DERs, depending on how they set up their grid codes (interconnection rules). Each DSO must only handle the DERs and ESOs operating in its own service area, which provides some limits on interface and system scaling issues for the DSOs. DSOs may

choose to require DERs to interface through ESOs to help contain interface scaling. The potential interpenetration of ESO DER accounts in a given DSO service area represents a complexity, but this industry structure, combined with another to be introduced later (laminar coordination networks), provide a general framework for architectures that manage the scalability issue for operational systems.

If distribution systems should evolve into platforms or networks for more general peer-to-peer energy transactions (which would require the elimination of net energy metering), then the DSO's role would include management of the network in a more general way, to include the following in addition to the usual reliability functions:

- internal power wheeling
- local interchange
- power flow scheduling
- network congestion management.

Later specifications such as the logical energy network (LEN) model support these potential new roles.

Specification 1 details

- 1.1 Distribution providers have a total DSO role.
- 1.2 The DSO is responsible for managing distribution assets in accord with an agreement with the TSO as to power and energy flows at the T/D interface substations.
- 1.3 The DSO is responsible for managing DER and power flows to, from, and inside its distribution service area to maintain distribution reliability and meet its responsibilities to the TSO at the T/D interface, including power and energy flows across that interface, and management of volatility arising from distribution-connected elements.
- 1.4 The TSO limits its grid observability to the BPS up to the T/D interface; it does not obtain grid state or operational data from DER devices or aggregators.
- 1.5 The TSO does not bypass the DSO to dispatch DER directly.
- 1.6 DER aggregators and other third-party energy services providers do not bypass the DSO to deal directly with the TSO.

3.3.2 Specification 2: Regulation via Power Electronics in Distribution Grids

In a traditional distribution grid, power flow control and voltage regulation are accomplished by utility-owned devices, such as distribution substation transformer load tap changers, feeder step-voltage regulators, and fixed or adjustable capacitor banks. These devices are located in medium-voltage distribution grids, are typically mechanical-switch based, and exhibit slow response and limited lifetime. Volt/VAR optimization and control are normally performed on a centralized day-ahead basis, using forecasted loads, supervisory control and data acquisition (SCADA) data, and a network model.

3.3.2.1 Voltage Regulation via DER Inverters

New power-electronics-based power flow control devices as shown in Figure 5 are emerging to provide fast response, flexibility, and efficiency. With power electronics, it is also possible to control the electrical waveforms (e.g., changing from dc to ac), meet harmonic requirements, control the power extraction from the prime mover sources, control output ac frequency, and control output voltage or current magnitude.

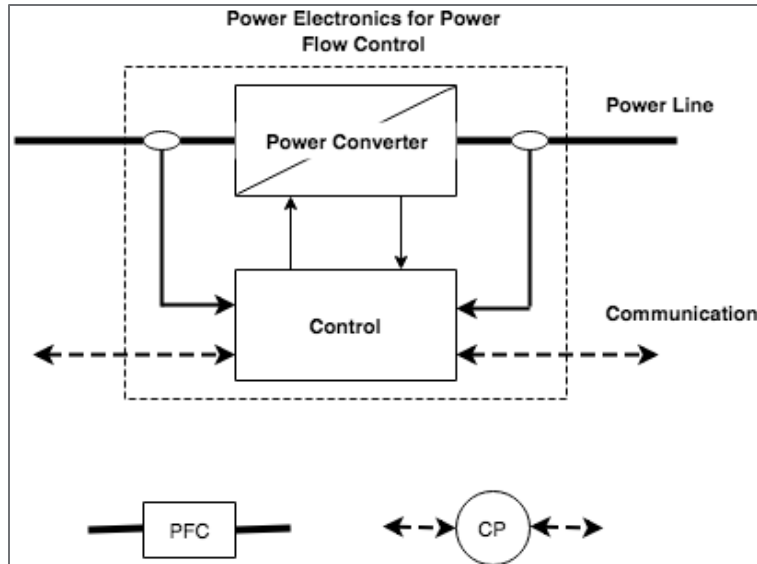

Figure 5. Internal Hardware Structure of a Power Flow Controller

The power flow control function exists essentially in all power electronics for grid applications, including high-voltage direct current, medium-voltage direct current, flexible ac transmission systems (static VAR compensator, static synchronous compensator [STATCOM], unified power flow controller, unified power quality conditioner [UPQC], etc.), and DER (including solar PV, energy storage, direct-drive wind turbine, microturbine, fuel cell, small hydroelectric, reactive source, etc.). Hereafter, we treat power electronics converters as common elements in a “terms” function, representing the physical hardware device and control point as denoted in Figure 6. In addition, we denote a power flow controller (PFC) between the DER and the grid as a Type-1 PFC, and a PFC between two grids or portions of one grid as a Type-2 PFC.

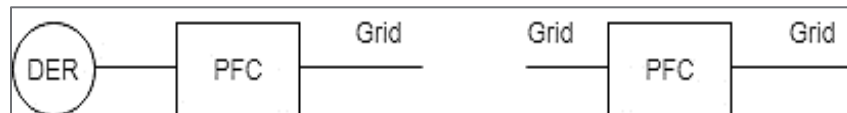

Figure 6. Two General Configurations of Power Flow Controllers

Examples of Type-1 PFCs are solar PV inverters or smart inverters,¹² which perform advanced control functions (supporting the grid or even forming a grid) beyond the basic grid infeed function. Examples of Type-2 PFCs are distribution (D)-STATCOM, UPQC, and solid-state transformers or substations.

3.3.2.2 Feeder Segmentation in Logical Energy Networks

A large amount of DERs, energy storage (ES), and DA makes it possible to create resilient distribution grid architectures that could be different from conventional radial, unidirectional power flow architecture.

Structure 1: Feeder Segmentation and Multi-Microgrid Network

¹² Y Xue et al., *On a Future for Smart Inverters and Integrated System Functions*, December 2018. Available via the DOE Public Access Plan (<http://energy.gov/downloads/doe-public-access-plan>).

Individual feeders (or even individual phases) can be partitioned or segmented into multiple virtual control areas or microgrids for autonomous power balancing, thanks to the availability of DERs. Between two neighboring segments, the PFC device can be “inserted” to electrically decouple their individual operations and to control tie-line power flow. This concept is illustrated in Figure 7.

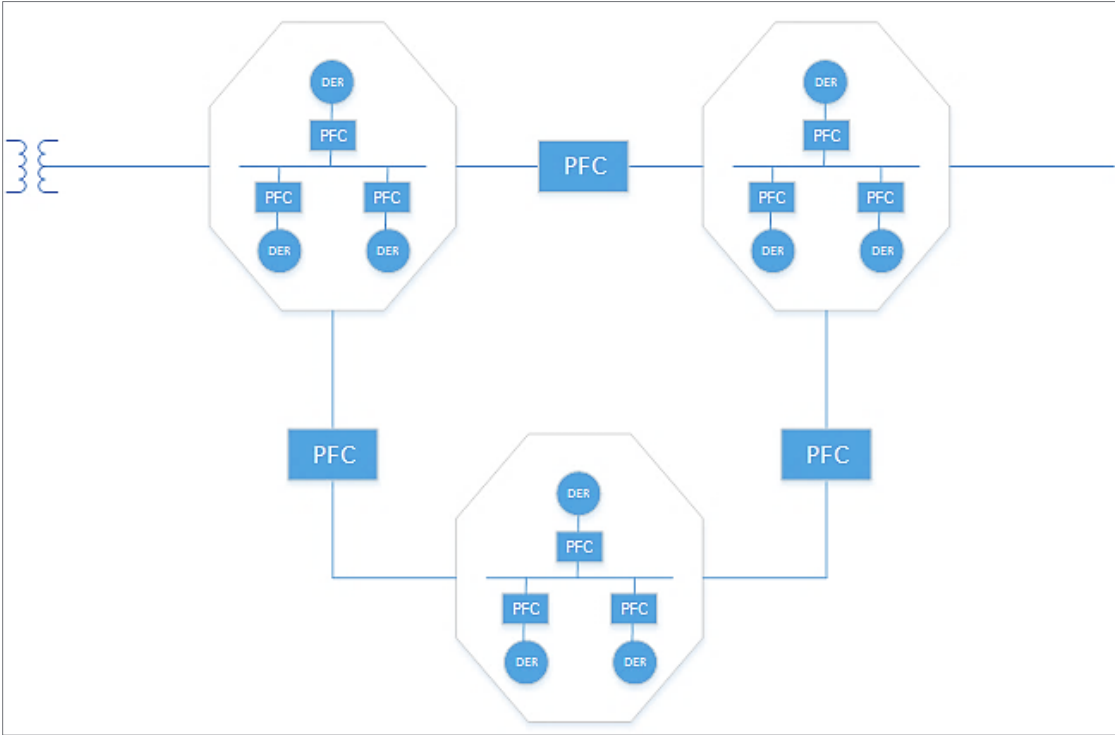

Figure 7. Distribution Feeder Segmentation

Structure 2: Meshed Distribution Network

Similar to a transmission grid, meshed networks can be formulated to improve distribution grid resilience. A simple three-bus network is shown in Figure 8.

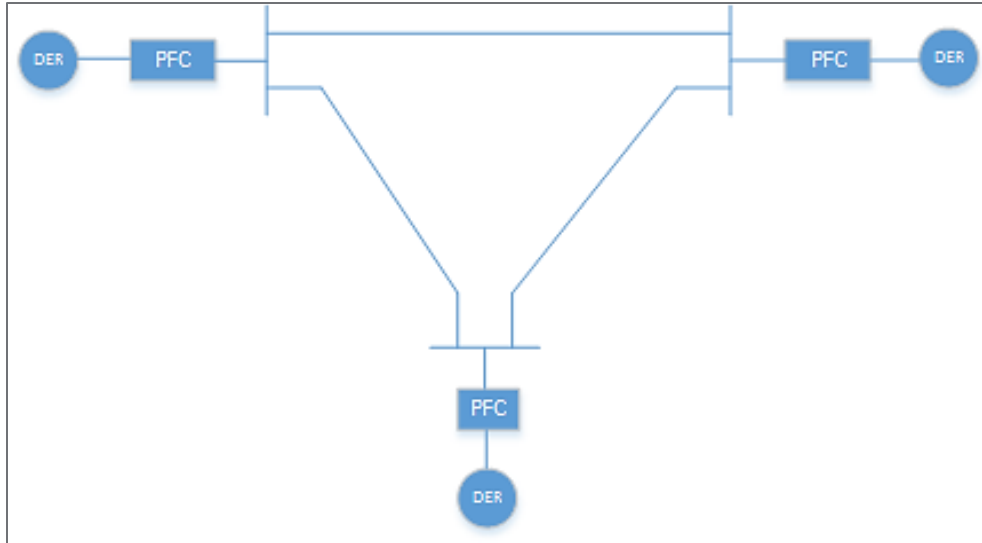

Figure 8. Simple Three-Bus Meshed Distribution Network

3.3.2.3 Volt/VAR Regulation

Traditional distribution Volt/VAR regulation is performed with a combination of centralized (substation transformer load tap changer) and slightly decentralized (feeder primary capacitor) means. As solar PV penetration increases, voltage volatility at the edge increases significantly, making the traditional methods ineffective. Increasing the sizes of components does not help much.

By applying Volt/VAR regulation locally on distribution secondaries (via power electronics), effective regulation is possible. This works because the power electronics device uses storage to buffer the local volatilities caused by insolation fluctuations. Such regulation may be via dedicated devices located at the service transformer secondaries or could be supplied as a service from coordinated DER inverters.

Specification 2 details

- 2.1 Use PFCs to decouple DERs from the grid where possible.
- 2.2 Insert PFCs to partition feeders into multiple virtual control areas for autonomous power balancing.
- 2.3 Coordinate DER inverters with grid control to avoid conflicts at the distribution secondary level and to provide regulation service.
- 2.4 Use decentralized volt/var regulation on distribution secondaries in preference to traditional methods when distributed solar PV is prevalent.

3.3.3 Specification 3: Distribution Layer Structure and Observability Platform

The layering and platform concepts are applied to electric infrastructure, sensing and measurement, and communications for electricity distribution to define a platform for resilient electricity distribution operations. Figure 9 shows a commonly used structure for electricity distribution utility sensing and control.

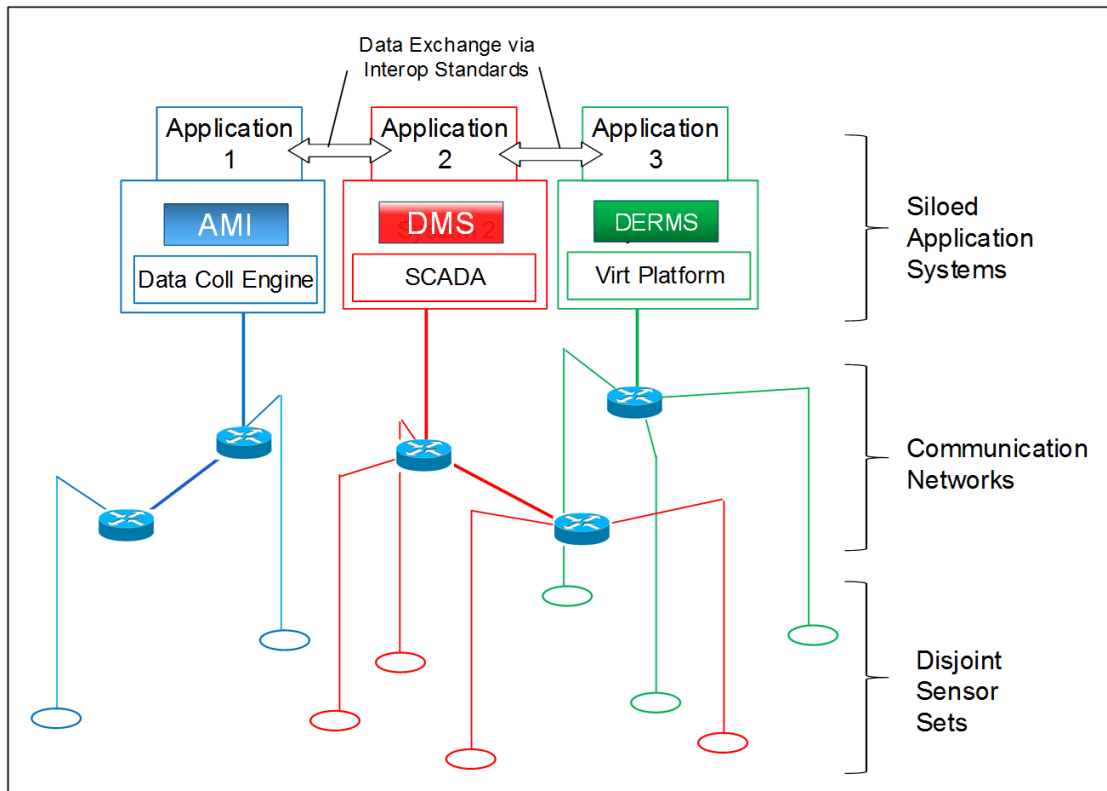

Figure 9. Siloed System Structure Results in System Brittleness (Anti-Resilience)

This multiple vertical silo structure is expensive as a result of back-end integration costs and degrades resilience because of that same back-end coupling of applications: failure in one can propagate through to degrade others. It also complicates extension, because adding or subtracting applications requires new integration to existing applications. Interoperability efforts attempt to simplify the integration problem but *cannot address the anti-resilience issue, which is fundamental to this structure.*

Figure 10 illustrates the layering and consequent decoupling of applications that limits brittleness and enhances configurability, functional flexibility, and functional extensibility.¹³

¹³ J Taft and P De Martini, *Sensing and Measurement Architecture for Grid Modernization*, PNNL-25249, February 2016. Available online: <https://gridarchitecture.pnnl.gov/media/advanced/Sensor%20Networks%20for%20Electric%20Power%20Systems.pdf>.

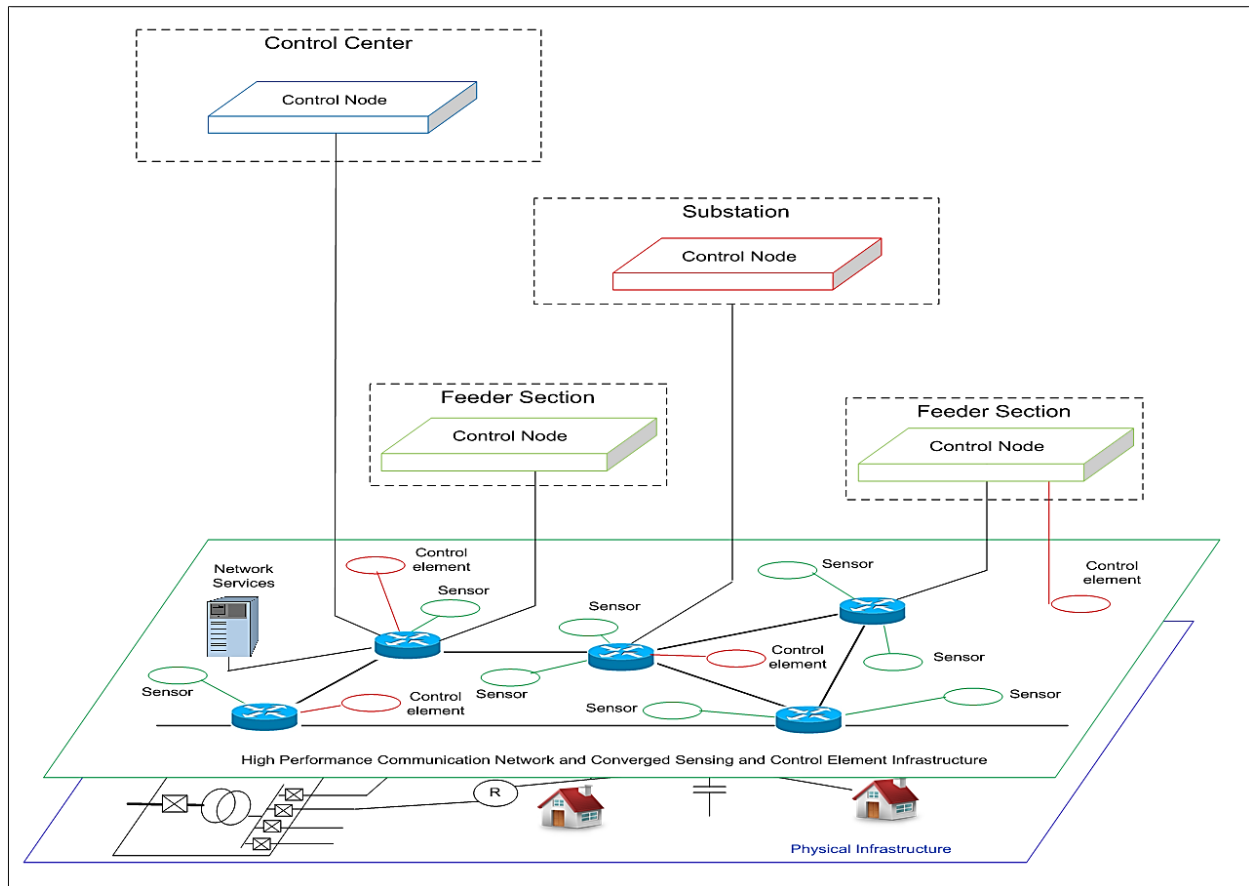

Figure 10. Sensor Communications Layer Structure

Note that this structure significantly changes the locations and the nature of interfaces between grid data sources and applications. This structure defines three layers and a distribution platform:

- Layer 1: electric infrastructure
- Layer 2: sensing and communications layer
- Layer 3: application layer.

This architecture facilitates the operation of the FAST DERMS in centralized, distributed, and (grid) fragmented modes.

Layers 1 and 2 constitute the platform. In addition to the physical components, the platform provides a set of functions and services that are depicted abstractly in Figure 11.

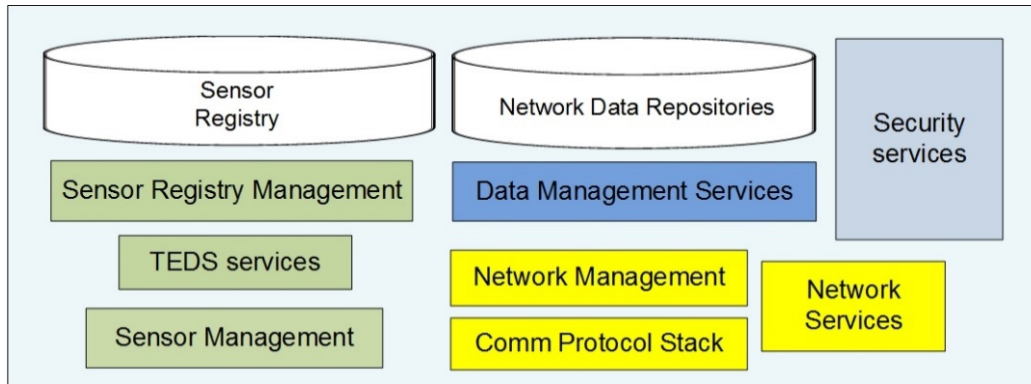

Figure 11. Sensor/Communications Infrastructure Layer Functions

This platform is a combination of typical communication functions and services, combined with two other items: services for sensors and selected data management services that may be implemented at the communication network level. Network management refers primarily to FCAPS (fault, configuration, administration, performance, security); TEDS¹⁴ refers to transducer electronic data sheets.

Specification 3 details

- 3.1 Treat sensing/measurement and communications as an infrastructure layer.
- 3.2 Make the communications network a full services IP network. In particular, provide streaming protocols so that the network can function as a distributed, access-controlled publish/subscribe mechanism.
- 3.3 Provide a set of functions and services for network, sensor, data, and security management as part of this layer.
- 3.4 Combine the electric distribution layer and the sensor/communications layer to form a distribution platform. Use this platform with the items from 3.2 to manage sensor data flows.
- 3.5 Decouple applications (analytics, control, forecasting, measurement & verification) by having each authorized application separately access the platform for the operational data it needs.
- 3.6 Locate applications as needed, including in operations or data centers, in substations, or in feeder-level devices. Applications may be dynamically relocated.
- 3.7 Circuit electrical control devices may be included in the sensing/communications layer of the platform.

3.3.4 Specification 4: Laminar Coordination Networks

A distributed system is one in which the various decentralized elements cooperate to solve a common problem, such as grid operation. The mechanism by which this cooperation occurs is *coordination*. A laminar coordination framework is a generator for coordination architectures for electric power systems that is derived from the mathematics of utility maximization via layered decomposition.¹⁵ The resultant structures are called laminar coordination networks. Figure 12 illustrates the basic structural elements that compose laminar networks. These derive from a mathematical approach to solving a wide class of optimization problems with multiple coupled constraints. The mathematics induce a structure that has

¹⁴ See IEEE 1451.4, *Standard for Smart Transducers*. Available online: <https://standards.ieee.org/content/dam/ieee-standards/standards/web/documents/tutorials/1451d4.pdf>.

¹⁵ JD Taft, *Architectural Basis for Highly Distributed Transactive Power Grids: Frameworks, Networks, and Grid Codes*, PNNL-25480, June 2016. Available online: https://gridarchitecture.pnnl.gov/media/advanced/Architectural%20Basis%20for%20Highly%20Distributed%20Transactive%20Power%20Grids_final.pdf.

been generalized to generate coordination architectures. The elements in Figure 12 provide building blocks and structure to assemble laminar networks for any specific grid or portion of a grid. Note that each laminar node requires intelligence (computing capacity).

The laminar coordination framework also anticipates the issue of third-party owner/operators of DER that is participating in grid operations. Third parties can complete laminar networks and handle communications to the nonutility DER devices.

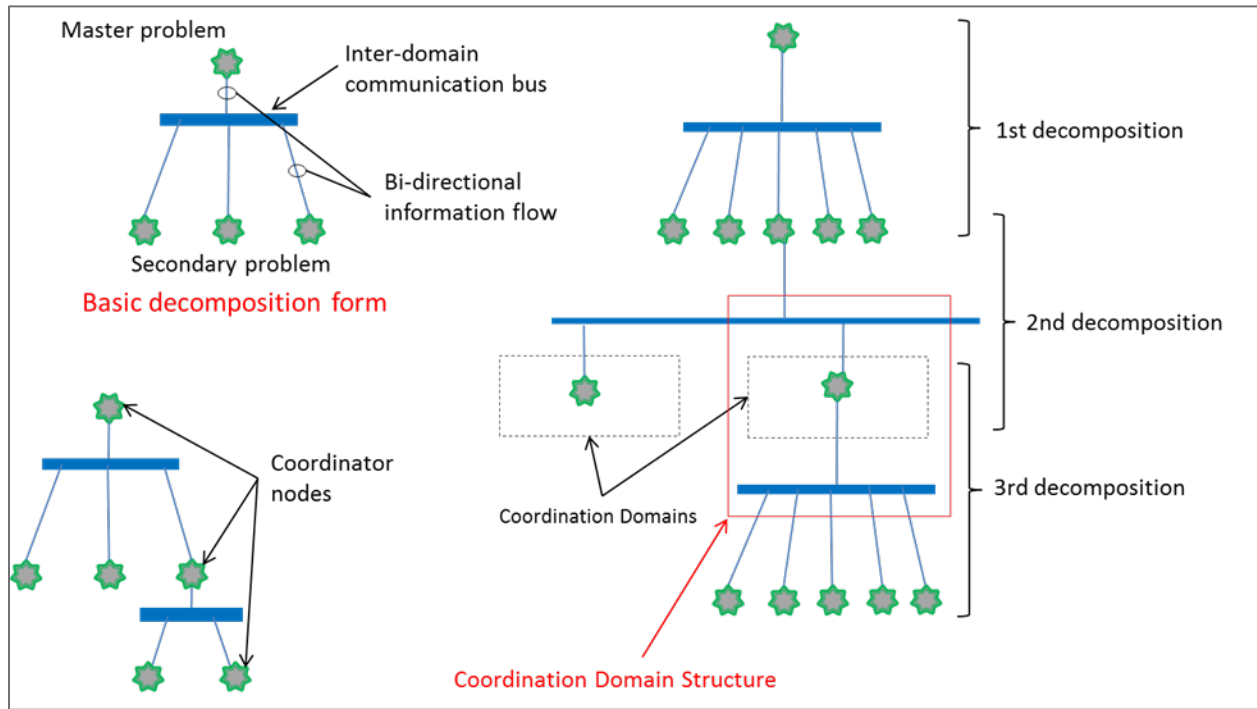

Figure 12. Laminar Coordination Framework Structural Elements

Each laminar coordination domain contains a domain coordination node, an intra-domain communication bus, any devices to be coordinated, the computing elements (hardware and software) needed for both the coordination node and the local applications (analytics, control, etc.) and northbound and southbound communication interfaces. Figure 13 shows a logical view of a coordination domain.

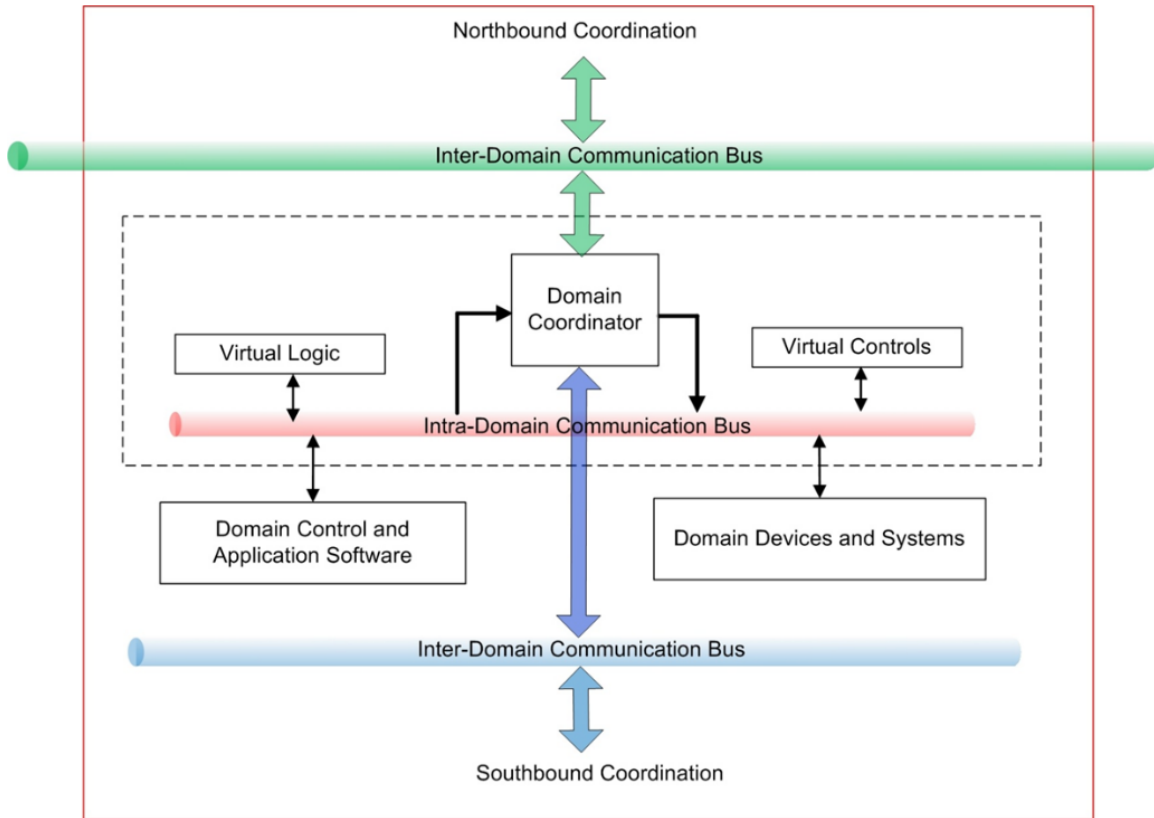

Figure 13. Laminar Coordination Domain Structure

Figure 14 shows an example of a laminar network. Note that the DSO/TSO structure of Specification 1 is completely compatible with the laminar coordination framework. In fact, the coordination root node could be extended to the TSO but typically does not need to be, as a result of the definitions of the roles and responsibilities for the total DSO model, which were derived in part from laminar coordination framework considerations.

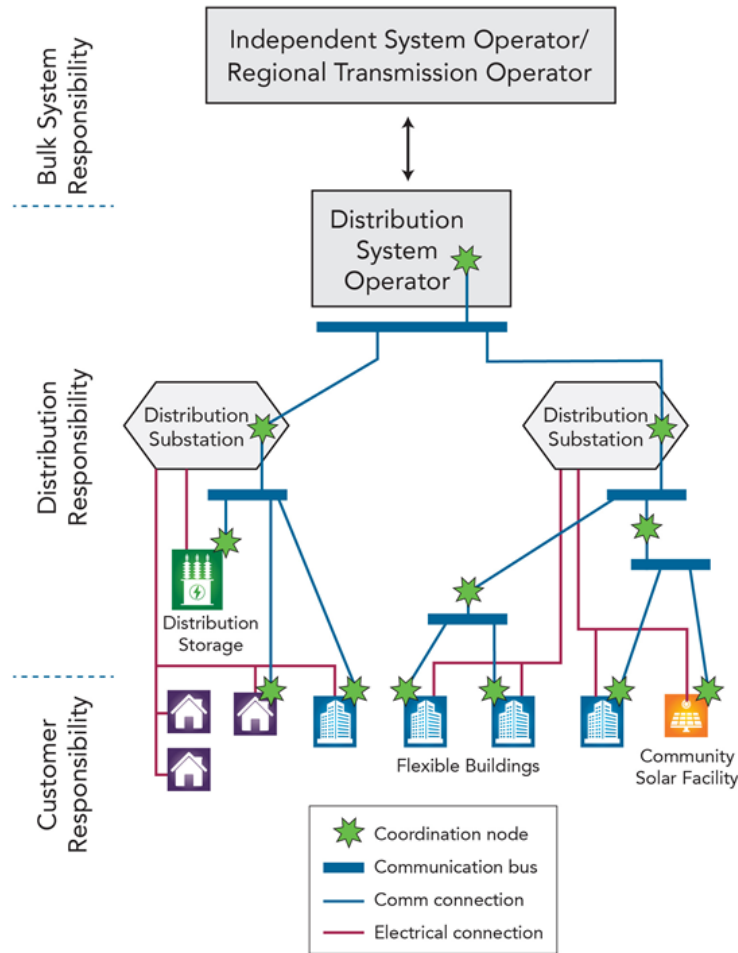

Figure 14. Example Laminar Network (Source: [Interoperability Strategic Vision](#), March 2018)

3.3.4.1 Treatment of Microgrids and Buildings in Laminar Networks

From the perspective of grid structure, buildings and microgrids present similar issues. Each may have loads, storage, and energy sources and be connected to a grid at a point of common coupling. Microgrids can be isolated from the grid (“islanded”) but so can buildings, via switchgear and protection. Modern buildings, especially commercial buildings, can be quite complex, with a vast array of internal systems and devices.

Many buildings have a building management system, which may be in the building or may be remote. In some cases, third-party organizations perform the building energy management and even aggregate various buildings for that purpose. For residential buildings this is less likely, but some simpler version of energy management, such as a Nest thermostat, may be present. In some approaches to advanced building control, individual energy-consuming devices interact with energy sources including the grid to obtain energy, provide comfort and utility, etc.¹⁶ Figure 15 illustrates a conceptual model for a stack-oriented building-to-grid interface.

¹⁶ B Nordman, *Grid Architecture for Buildings*, Lawrence Berkeley National Laboratory, December 2019. Available at <https://drive.google.com/file/d/1Ld6IE9Hzgh6k1F3P-kZl0buoHQRQ8lho/view>.

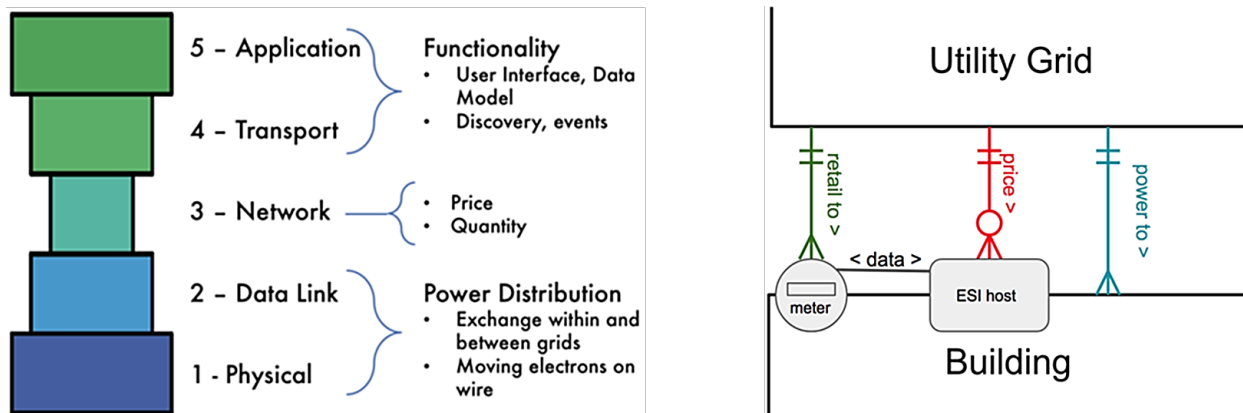

Figure 15. Building-to-Grid Interface Models. ESI is energy services interface.

From the standpoint of the grid, the layered decomposition model as applied in Specification 1 provides a consistent means to handle exchange of services between building and grid. Essentially, the building management system (BMS) plays the role equivalent to the DSO, and the distribution system plays the role equivalent to the TSO. In other words, the structure model is repeated on the scale of building-to-grid, instead of DSO-to-TSO. Agreement is reached at the common point of connection on the exchanges and the grid does not need to have visibility into the interior state of the building. In return, individual devices in the building interact with the grid only via the BMS. This allows for a clean interface and clear roles and responsibilities, exactly as with the grid itself. Because the laminar coordination framework yields multiscale structures, the method works as well at the building level as at the grid level.

In the forgoing paragraph, replace “building” with “microgrid” and the rest applies exactly. It is also feasible to continue the structural recursion and apply laminar structure inside the building or microgrid.

Specification 4 details

- 4.1 Use the laminar coordination framework to develop specific laminar networks that correspond to the actual physical system being coordinated.
- 4.2 Follow the framework to define logical information flows for the coordination process.
- 4.3 Maintain laminar structure, even when DERs are being coordinated via aggregators or other third parties.
- 4.4 Third parties can host laminar nodes on behalf of the DERs they aggregate.
- 4.5 Connect aggregators to the appropriate DSO to participate in the coordination data flows for the DERs they manage in the service area of the DSO. Aggregators and other third parties may connect to more than one DSO if they have DERs in more than one DSO service area (refer to Specification 1).
- 4.6 Provide computing capacity at the node locations to implement laminar node functions.
- 4.7 Use laminar structure to define building-to-grid and microgrid-to-grid interfaces.

3.3.5 Specification 5: Storage

Reflexive grid energy storage may exist at any of several levels and forms in the grid:

1. grid-scale bulk storage, used mainly for grid services
2. embedded core infrastructure storage, used for generation/load decoupling (including outage ride-through), volatility export suppression, and even cybersecurity improvement¹⁷
3. storage that is purpose-built for a variety of more or less dedicated uses, including maximizing electricity market profit, minimizing operational cost, improving reliability, and minimizing energy loss at the distribution level (typically utility-directed)
4. BTM storage that has a primary purpose at a physical (nonutility) site and also may act as either a distribution-level or BPS grid resource (energy supply, flexibility/resilience, or grid services).

Specification 5 details

- 5.1 Use laminar coordination structure to coordinate BTM and secondarily-connected storage with other grid resources and devices. This applies to third-party-operated storage as well as owner-operated storage.
- 5.2 BTM/secondarily-connected storage coordination elements or functions must fit into a larger laminar coordination framework so that coordinating storage does not conflict with other distribution-grid control devices and systems.
- 5.3. If BTM/secondarily-connected storage is to be used as a BPS resource, the coordination mechanism must not introduce coordination framework gapping or tier bypassing and must not enable hidden coupling, including via markets.

For BTM/secondary-connected storage, coordination among storage devices and with other grid devices and DER is necessary.

3.3.6 Specification 6: Logical Energy Networks and Distribution Virtualization

DER may be used to support grid resilience, but present grid structure makes this difficult. Figure 1 and Figure 2 show distribution systems organized by substation service area. This is done in part by physical infrastructure but, more importantly, by imposing virtual structure via control systems. The existing structure represents a constraint on the use of DER for resilience purposes at both the distribution and BPS levels. Logical energy networks are structures that virtualize distribution systems to exploit the latent capacity of DER for resilience purposes. A LEN is a distribution-level virtual structure specified and enforced through coordination and control processes. It is a portion of a distribution system that is segmented in a way that is roughly analogous to bulk system balancing areas. It is not a virtual power plant. There may or may not be underlying circuit elements (such as sectionalizers, boundary sensors/meters, power flow controllers) involved. LENs may be thought of as virtual microgrids, but islanding capability is not required.

¹⁷ R O’Neil, A Becker-Dippmann, JD Taft, *The Use of Embedded Electric Grid Storage for Resilience, Operational Flexibility, and Cyber-Security*, PNNL-29414, October 2019. Available online: https://gridarchitecture.pnnl.gov/media/advanced/The_Use_of_Electric_Grid_Storage_for_Resilience_and_Grid_Operations_final_PNNL.pdf.

A LEN is a segment of a primary feeder with associated devices and loads. Ideally, each LEN has three energy sources available to it:

- It is fed from two primary distribution feeders.
- Some amount of DG/DS resources that is utility controlled or coordinated is internal to the LEN.
- Other nonutility controlled DER may or may not exist in a given LEN.

A LEN has logic that manages

- local balance (see three sources requirement above)
- Volt/VAR regulation (local)
- grid services resource management (local)
- local outage management

LENs operate in a cellular fashion, like a microgrid network, and can function as “resilience cells.” LENs operate autonomously when needed and are globally coordinated, normally via laminar coordination networks. LENs are disjoint, meaning they do not overlap in terms of physical infrastructure. LENs are contiguous and complete, meaning they cover the entire distribution system with no gaps. Figure 16 shows a distribution feeder with LEN virtual structure superimposed.

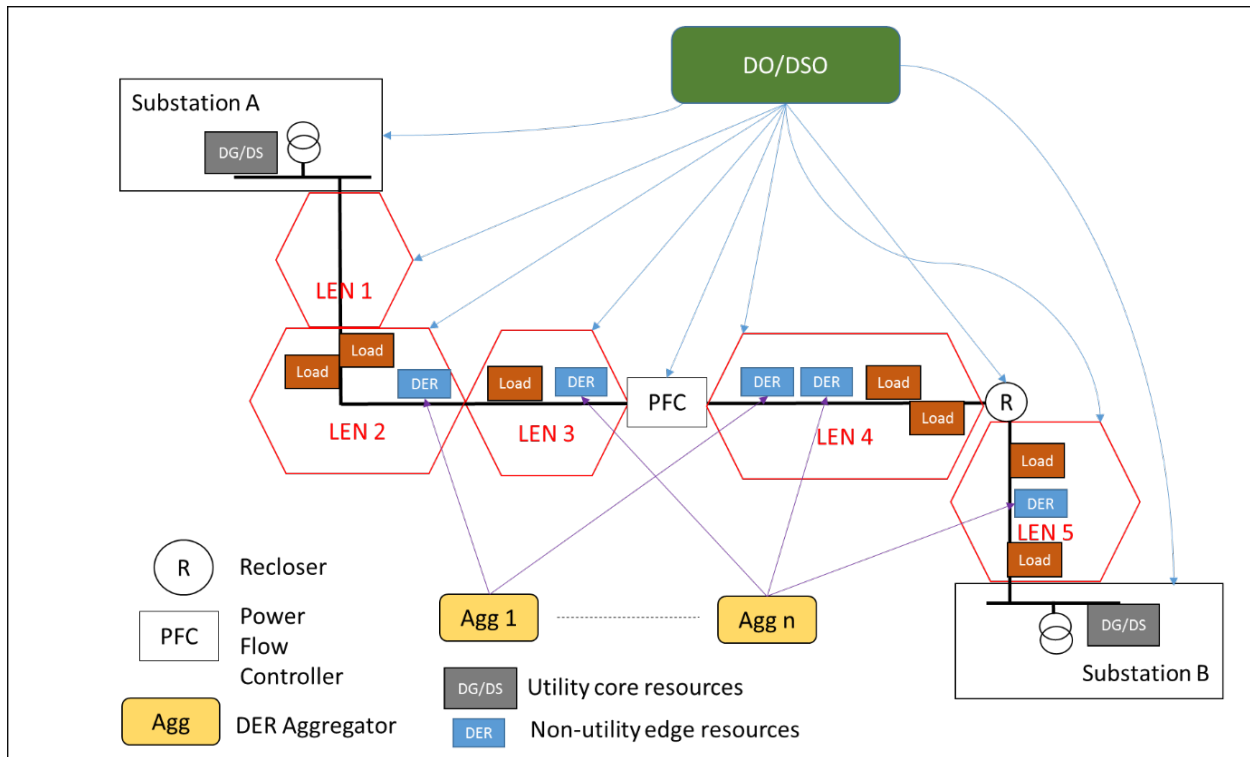

Figure 16. Example Feeder LEN Structure

This structure recognizes two classes of DER:

- edge resources (not utility owned and possibly not controlled directly by a DSO)
- core resources (utility owned/controlled by DSO).

LENs interact with each other electrically (on a nearest-neighbor basis) to carry out

- power wheeling
- interchange
- inter-LEN outage support
- inter-LEN Volt/VAR support.

Given the LEN structure, Figure 17 shows the new stack model for the grid. Note the degree of parallelism between the structures of the BPS and the LEN-based distribution system. For the BPS to make use of the LENs, it must operate through the DSO, as indicated in Specification 1.

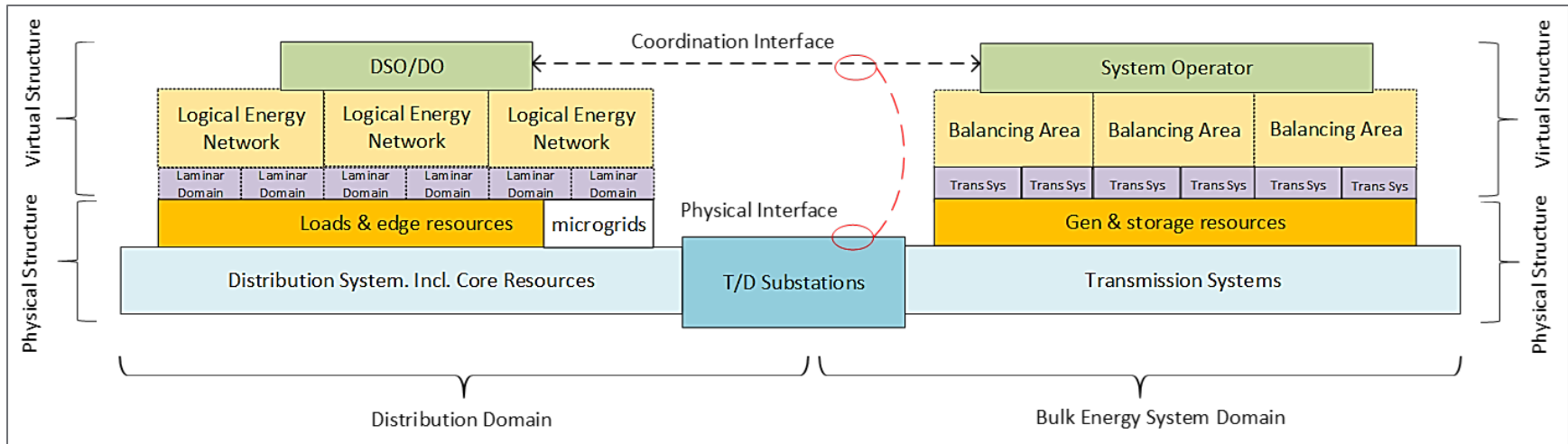

Figure 17. Grid Stack Model Diagram with LENS

Note that the LENs are composed of laminar domains; in fact, each LEN constitutes a laminar domain itself, but may be further decomposed by layers. Organizing the DER under the LEN/laminar structure improves the effectiveness with which the DSO makes use of the DER on a spatially and temporally granular basis for both itself and the BPS. For more information the concept of operation for LENs, see the white paper, *Logical Energy Network Concept of Operations*¹⁸. Each LEN can function as a laminar coordination domain, and the laminar node can coincide with and be hosted on the same computing element as the LEN logic. Both are compatible with the distributed intelligence approach of the Open Field Message Bus.^{19,20}

3.3.6.1 Operation Under Extreme Stress Conditions

Both laminar coordination and LENs can suffer disruption during extreme events such as severe storms, fires, etc. In such cases, electrical and communication infrastructure may be destroyed. Then the overall structure may be fragmented, and resources may be isolated and unavailable at any given service point. In such cases, it is important that LENs or even fragments of LENs be able to continue operation to the extent possible given the infrastructure damage. For this reason, *distributed intelligence* is needed (as opposed to centralized, virtualized, or cloud-based intelligence), with capabilities to determine what resources remain available locally and to organize and operate those resources to meet local objectives. This may include cooperation with and support of neighboring LENs, if such is possible, or it may mean operation in complete isolation.

Specification 6 details

- 6.1 Each distribution system is composed of a set of non-overlapping, contiguous LENs.
- 6.2 Each LEN constitutes a laminar domain and may be further decomposed into lower-level laminar domains as needed.
- 6.3 Each LEN has two separate feeder connections plus an internal, utility-controlled set of core DER (DG and/or DS) resources so that it has three ways to obtain energy.
- 6.4 Each LEN has a local control/intelligence capability that supports local load and energy resource management, as well as operation under grid fragmentation.
- 6.5 LENS are coordinated via laminar coordination and a DSO.
- 6.6 LENs may or may not have physical islanding capability but can act as virtual microgrids when necessary.
- 6.7 LENs act as combined load and energy resources for the DSO.
- 6.8 LENs support neighbor LENs via power wheeling and interchange, outage support, and volt/var support.

3.3.7 Specification 7: Fault Location, Isolation, and Service Restoration (FLISR)

FLISR is made up of several fault management steps:

- detection
- characterization

¹⁸ LEN ConOps v0.3.pdf available in package at https://gridarchitecture.pnnl.gov/media/zip/High_DER_DA_Sto_Reference_Architecture_package.zip

¹⁹ OpenFMB Collaboration site: <https://openfmb.github.io/>.

²⁰ S Laval and B Godwin, *Distributed Intelligence Platform (DIP) Reference Architecture Volume 1: Vision Overview*, January 5, 2015.

- location
- isolation
- service restoration (short term)
- service restoration (long term, after fault correction)

A consideration of various approaches to fault detection, characterization, and localization suggests the value of distributed intelligence.²¹ Detection, characterization, and location are greatly aided by distributed sensing and analytics, so that the architectures of Specifications 3 and 8 apply. See also Specification 10, section 10.4.

Isolation and service restoration depend largely on circuit structure. With simple radials, very little can be accomplished besides simple sectionalization ahead of the fault. With increasing feeder meshing, more possibilities exist for rerouting power flow. This causes a DER management issue: DER is not always connected to the same feeder and same substation. DER coordination for supporting grid operations must consider real-time grid structure, which can be altered quickly by FLISR, protection, power flow control, and severe events.

Specification 7 details

- 7.1 Use distributed sensing and intelligence architectures to support fault management.
- 7.2 Use circuit meshing as feasible to provide options for rerouting power around isolated faults.
- 7.3 DER management must include access to real-time circuit topology state, including grid fragment topology.

3.3.8 Specification 8: Distributed Intelligence Platform

Distributed coordination and control require both computing and communications support. For the computing portion, digital processing capability must be located throughout the grid. At each level in the grid hierarchy, connected processing capability must provide not only computing hardware but three layers of firmware/software. Figure 18 illustrates the places in the grid where computing can be located and examples of the contents of the three soft layers that reside on the computing hardware. The combination of these and the communications layer constitute a distributed intelligence platform.

²¹ J Taft, Fault Intelligence: *Distribution Grid Fault Detection and Classification*, PNNL-27602, September 2017. Available online: https://gridarchitecture.pnnl.gov/media/white-papers/FaultIntelligence_PNNL.pdf.

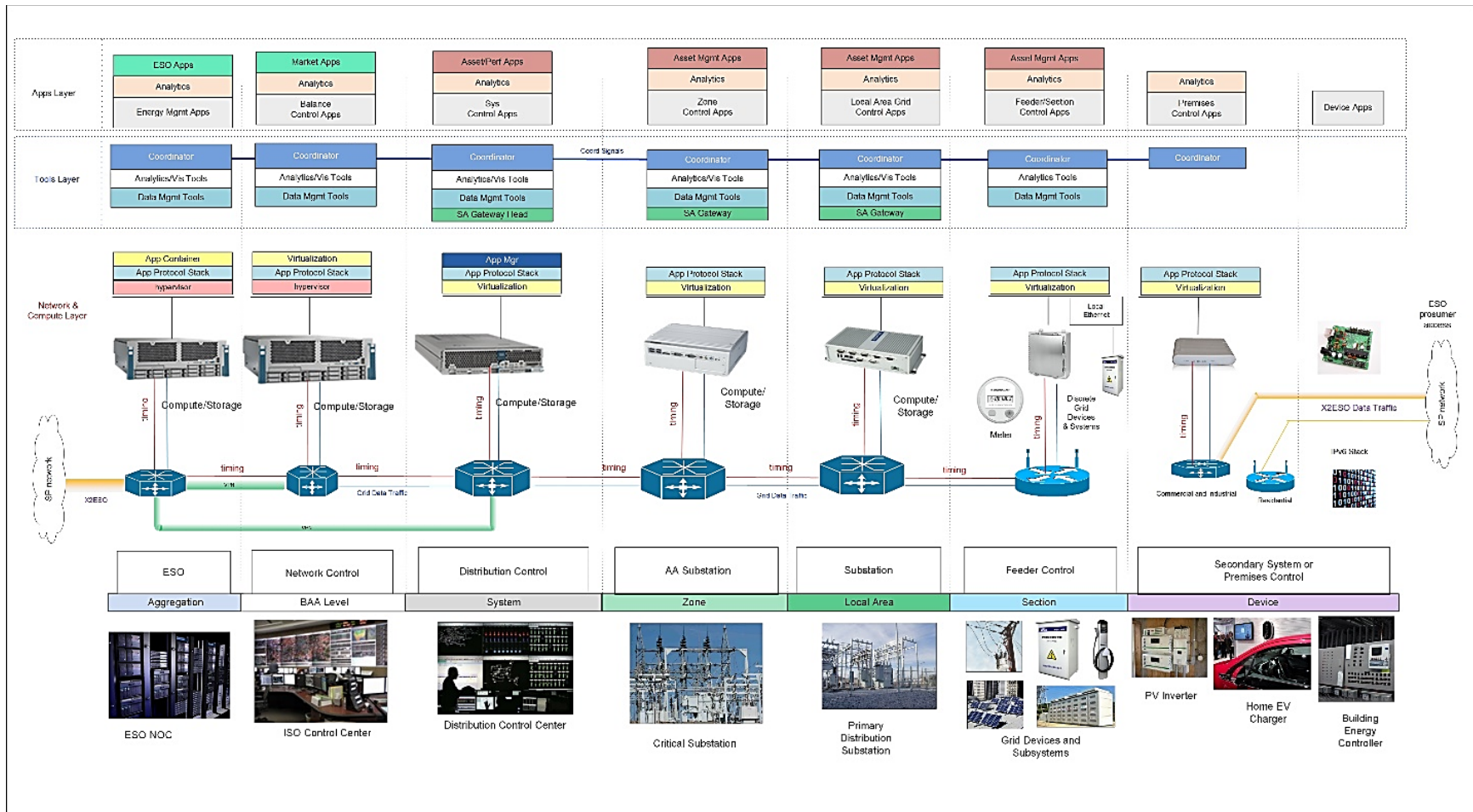

Figure 18. Electricity Grid Distributed Intelligence Platform

Note that the use of laminar networks (Specification 5) implies that computing and communications must extend past the boundaries of the utility itself and into the DER devices and third parties that participate in grid operations. In addition to the control or operations centers, intelligence may exist in the substations, at the distribution feeder sensing and control devices, at the residential, commercial, and industrial meters,²² in solar PV and battery storage inverters, in electric vehicle chargers, and in responsive load devices. Computing capacity for distributed intelligence may even reside on the communications devices themselves.

Specification 8 details

- 8.1 Provide computing hardware and software support for applications as needed throughout the grid.
- 8.2 Use a five-layer platform model: communications, computing hardware, operating firmware/software, tools software, and applications software.
- 8.2 Provide the means to manage applications for the distributed computing platform, including FCAPS, over-the-air download and update, and application control.
- 8.3 Provide communication connectivity that supports both device-to-control-center communication and peer-to-peer communications, including laminar network coordination communications.
- 8.4 Include intelligent grid devices such as advanced switches, inverters, and sensors in the distributed intelligence architecture, even if they cannot host third-party applications.
- 8.5 Incorporate comprehensive cybersecurity measures in the communications networks and the computing devices. Include six-wall physical security for grid (electric utility-owned) devices.

3.3.9 Specification 9: Cybersecurity Structures

A wide array of standard network security measures, devices, and methods have been developed and are in practice in many utilities. In practice, network-level security should be viewed as a multilayer, multi-measure framework based on four pillars:

- access control
- data integrity, privacy, and confidentiality
- intrusion resistance, detection, and mitigation
- device and platform integrity.

Using these as basic principles, an extensive variety of technical measures may be applied at the communication network level. These are all available in product form and so can be applied at the design stage. An understanding of these is helpful for developing the architectural specifications that facilitate or require such measures.

The following is a list of standard network cybersecurity measures that any communication network operator should include as the minimum to be considered as part of a comprehensive cybersecurity program. It does not address people and process issues, but those are vital as well. Two processes to consider are manufacturing supply-chain security management and secure code development and code hardening (against buffer overflow, self-modification; remove unnecessary protocols).

²² B Seal, *Transforming Smart Grid Devices into Open Application Platforms*, EPRI report 3002002859, July 2014. Available online: <http://smartgrid.epri.com/doc/SG%20Informational%20Webcast%20Open%20Apps%20V2.pdf>.

The technical measures are listed here:

- crypto: link layer, group, and application layer
- role-based access control (RADIUS and TACACS; AAA; NAC)²³
- mutual authentication; media-independent identity authentication protocols
- X.509, secure key generation and management, scalable key management (DMVPN, GETVPN, for example)
- security information and event management (SIEM), firewalls
- intrusion prevention system (IPS), including SCADA IPS signatures
- containment: virtualization and segmentation
 - VRF – virtual routing and forwarding
 - Multiprotocol Label Switching (MPLS) virtual private network (VPN) and virtual local area network (VLAN)
 - data separation
- tamper-resistant device design, digitally signed firmware images, firmware/patch authentication and integrity verification
- digitally signed commands
- rate limiting for denial of service (DOS) attacks
- wire speed behavioral security enforcement
- packet tamper detection, replay resistance
- SUDI 802.1AR (secure device identity)
- access control: VLANs, ports
- storm detection and traffic flow control: traffic policing and port blocking
- Address Resolution Protocol (ARP) inspection; Dynamic Host Configuration Protocol (DHCP) snooping
- honey pots/honey nets/sinkholes
- unicast reverse path forwarding (Internet Protocol [IP] address spoofing prevention)
- hierarchical quality of service (QoS)
- security policy managers
- medium access control (MAC) layer monitoring
- control plane protection (coarse packet classification, virtual routing and forwarding (VRF)-aware control plane policing)
- six-wall physical security for devices and systems; access detection and mitigation (i.e., port shutdown)

²³ Radius is Remote Authentication Dial-In User Service; TACACS is Terminal Access Controller Access-Control System; AAA is authentication, authorization, and accounting; NAC is network access control.

- air gapping (physical network isolation, data diodes)
- structure for securability.

Some related security elements that are not network components or functions include

- secure code development and code hardening (against buffer overflow, self-modification; remove unnecessary protocols)
- manufacturing supply-chain security management
- data quality as tamper detection
- anti-counterfeit measures
- security posture assessment.

A variety of people and process elements also must be included to secure power grids but are beyond the scope of this document.

In addition to these standard approaches, consider the effect of structure on cyber vulnerability. Vulnerability is related to connectivity, and the grid has two forms of connectivity: communication and electrical. Choice of structure to minimize attack avenues is a valid technique and, in this regard, laminar structures provide better characteristics than hub-and-spoke arrangements that are common in SCADA and some DER management architectures.

Specification 9 details

- 9.1 Systematically apply the network level security measures listed above
- 9.2 Consider the effect of structure and choose structures that inherently limit vulnerabilities by limited exposure of device, systems, and entities.
- 9.3 Consider the use of resilience as a cyber defense, instead of relying only on IT-type defenses.

3.3.10 Specification 10: Distribution Automation and Distributed Control

This reference architecture presumes a high level of DA, involving all aspects of distribution control (power flow, Volt/VAR regulation, stabilization, synchronization, protection, and DER coordination). The specification focuses on structures, not algorithms.

3.3.10.1 Distribution Grid Control Structures with DER Coordination

The layered decomposition framework provides a common basis for developing distribution control architectures involving DER. Four specific examples follow to illustrate the commonality across applications.

Non-utility Distributed Generation

Generators may be attached to distribution grids and may be owned by non-utility entities. Since their operation affects grid operations, they must be coordinated and controlled in a beneficial manner that avoids creating reliability issues. Figure 19 shows how to apply laminar structure so that the utility, the generator devices, and any possible third parties can operate in a coordinated manner. Note that the cluster control layer may be implemented at the utility or by DG operators (who may be separate from the DG owners). This structure mirrors the layered decomposition framework shown in Figure 12 in Specification 4.

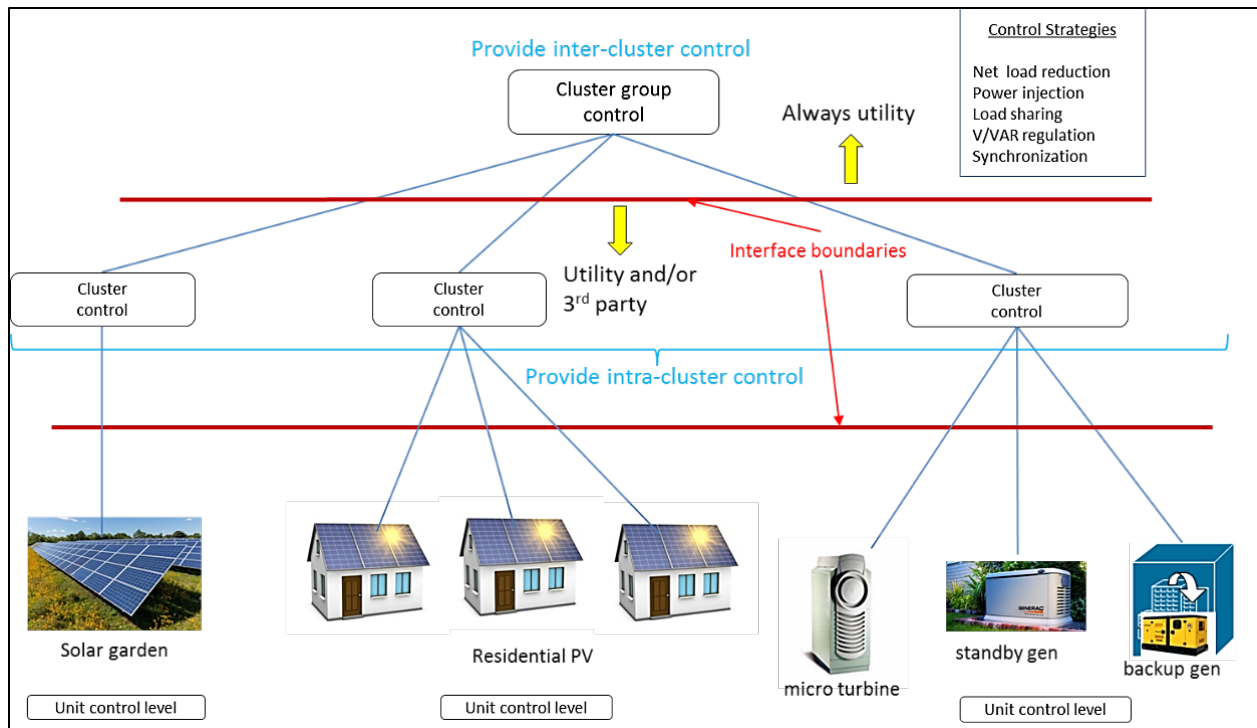

Figure 19. Laminar Coordination of Distributed Generation

Injection/Inverter Control

Many DER devices interface to the grid via power electronic inverters so they can inject energy into the grid. It has been proposed that such devices could not only provide the power injection interface, but also participate in Volt/VAR regulation. If the control of such devices is purely autonomous on a per-device basis, the potential for interference and reliability compromise exists. The problems can be avoided through use of a properly structured coordination framework, as illustrated in Figure 20. Note the similarity to Figure 19. This framework also applies to grid-forming inverters,²⁴ even if the utility is not involved. In that case, the top-level coordination node resides in the inverter network.

²⁴ S Xue, *Grid Forming Inverters*, PowerPoint Presentation, ORNL, June 2019.

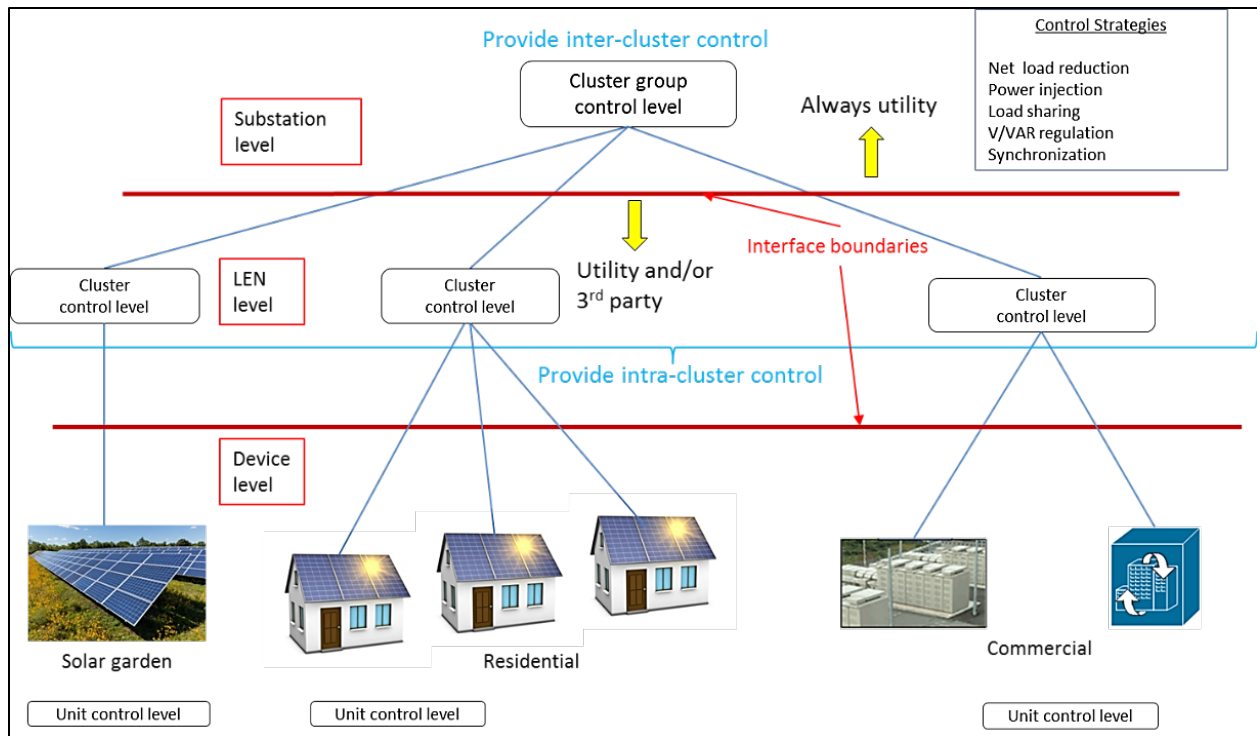

Figure 20. Laminar Coordination of Inverters

Electric Vehicle (EV) Charging Networks

EV charging networks represent a special case in that a potentially scarce resource (charging capacity) may need to be allocated among vehicles (only if insufficient charging capacity exists at the charging points). In this case, not only does the same framework structure apply, as shown in Figure 21, but the layered decomposition mathematics has been developed for the analogous case of allocating cell tower bandwidth to cell phones to provide implementations for the actual control strategies, using α -fairness²⁵ or power-constrained rate allocation.²⁶

²⁵ M Chiang, SH Low, AR Calderbank, and JC Doyle, "Layering as Optimization Decomposition: A Mathematical Theory of Network Architectures," *Proceedings of the IEEE*, Vol. 95, No.1, Jan 2007. Available at <https://ieeexplore.ieee.org/stamp/stamp.jsp?arnumber=4118456>.

²⁶ D Palomar and M Chiang, "Alternative Distributed Algorithms for Network Utility Maximization: Framework and Applications," *IEEE Transactions on Automatic Control*, Vol. 52, No. 12, December 2007. Available at <https://ieeexplore.ieee.org/document/4395184>.

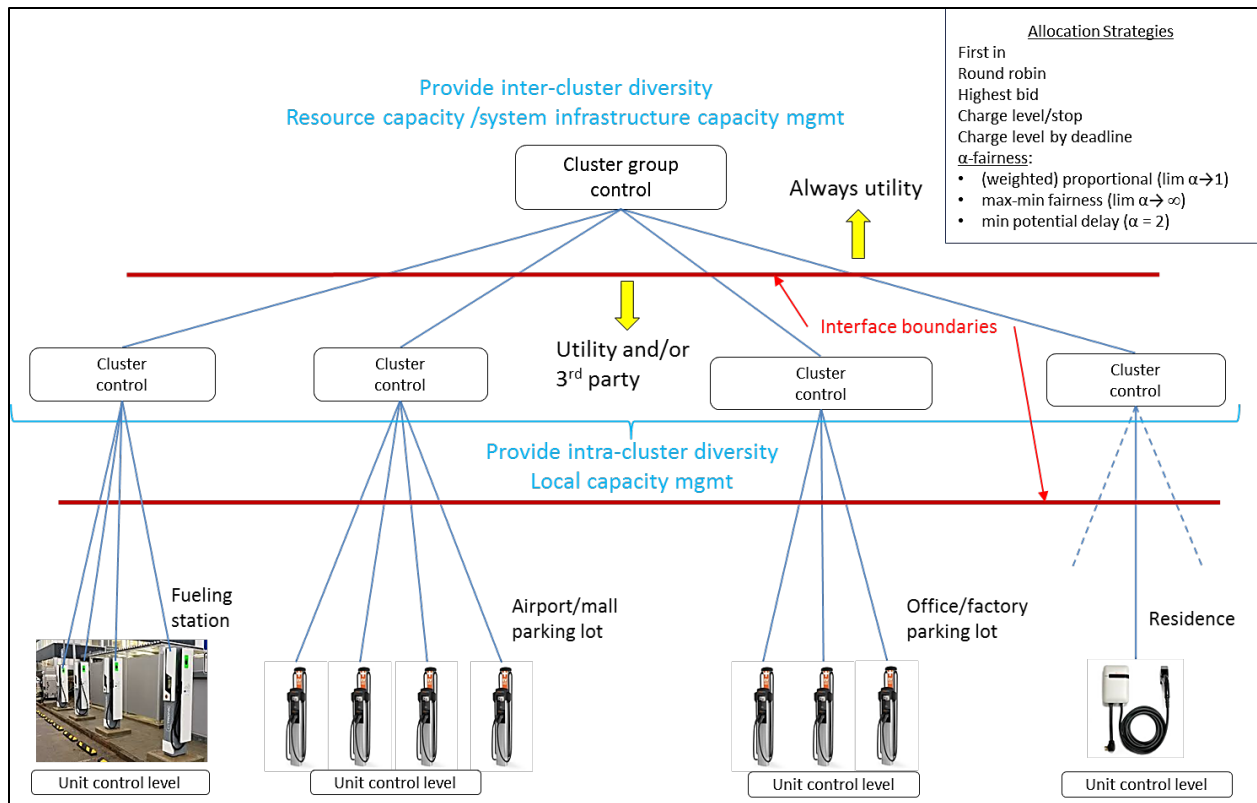

Figure 21. Laminar Control of EV Charging Networks

Note that the same basic methods also provide solutions for optimal scheduling, routing, and congestion control, which could be applied to distribution network operations in the context of using the distribution systems as an energy transaction platform. In other words, the control of flow control and Volt/VAR regulation devices could be managed by the utility using similar methods and structure.

Heterogeneous DER Networks

When DER develops “organically” (meaning not planned by the electric utility), the utility may be faced with coordinating mixed sets of resources that vary in location and time. The use of the LEN concept is helpful because it provides a means to virtualize the distribution physical layer so that management methods above the LEN layer do not have to shift constantly to accommodate changes in underlying physical DER. Figure 22 shows how this mapping fits into the same structural framework as the other examples above.

Using the laminar network methods, third-party operators of DER can be accommodated. However, note that when net energy metering tariffs are eliminated, the utility need not necessarily work through intermediaries. An emerging mode for DER control is for the utility to provide a tariff payment that is essentially for use of the DER in a capacity mode; that is, there are no stacked values and no real-time, market-like mechanisms. Instead, the owner agrees to allow the utility to operate the DER in any mode it wants (within limits that protect the owner) and for any operational purpose that utility may have at any time, for which the owner receives a simple payment.

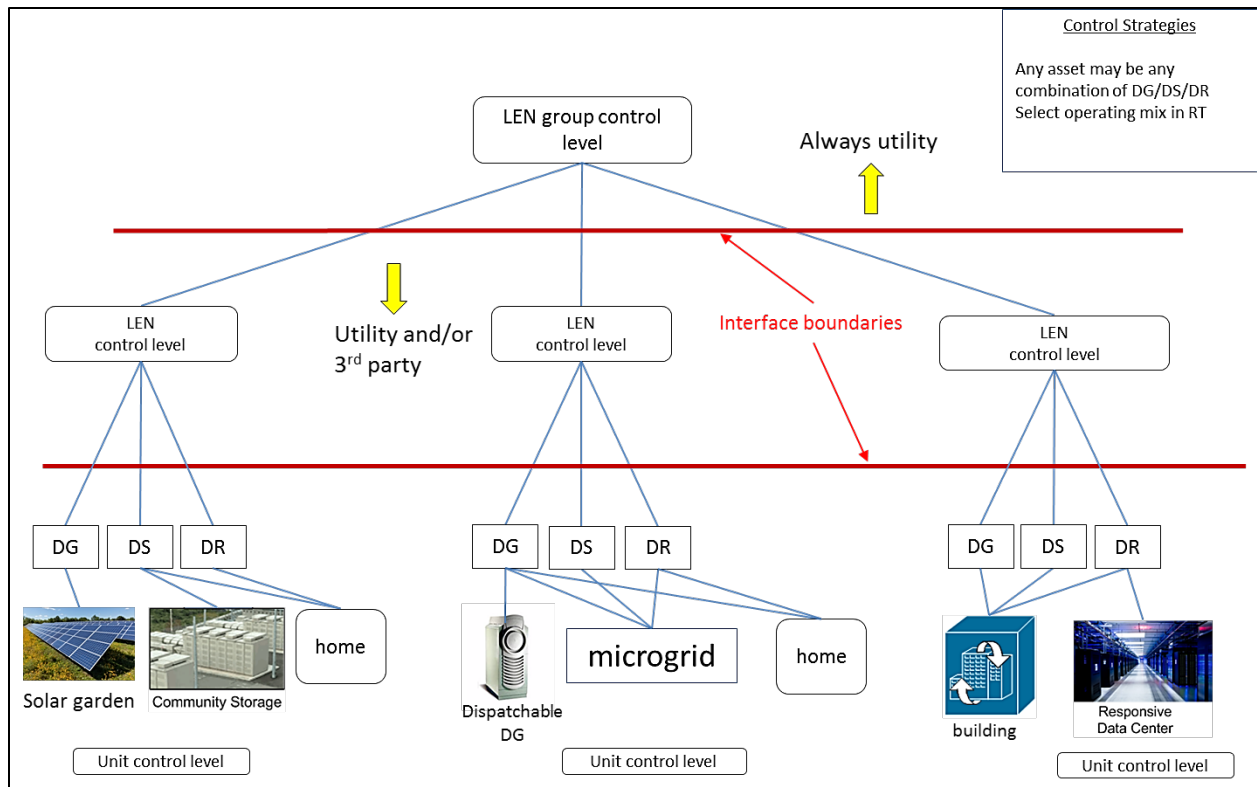

Figure 22. Layered Control of Heterogeneous DER Networks

3.3.10.2 Feeder Control

Control structure addresses power system control in the presence of large numbers of customer, utility, or third-party owned distribution-connected assets (DER) and utility DA. This structure supports a combination of centralized, decentralized, and distributed control mechanisms. The support for a range of mechanisms takes into account that for some time, many distribution systems will have varying penetrations of DER, and thus require multiple control approaches. The control structure considers scalability and evolution of control strategy with growing DER penetration. The control objectives considered include regulation of voltage, reactive power and frequency, stability, power flow including congestion management, and synchronization.

The control and coordination structure must accommodate DER penetration at varying levels and within both radial and meshed feeder topologies. It must also be robust against structural variability in system topology that occurs through the operation of DA devices such as automated reclosers. This is illustrated in Figure 23, which is based on an urban, meshed-network portion of a large distribution system. Note that BTM DER may be distributed on any segment, and that microgrids may be attached through a recloser to any given segment, and utility-scale DER as well, in this case directly at the substation. Generalizing this example, several structural considerations for control and coordination with DA are apparent. Accommodating the range of possible operational configurations requires that the structure start with control and coordination of each individual segment.

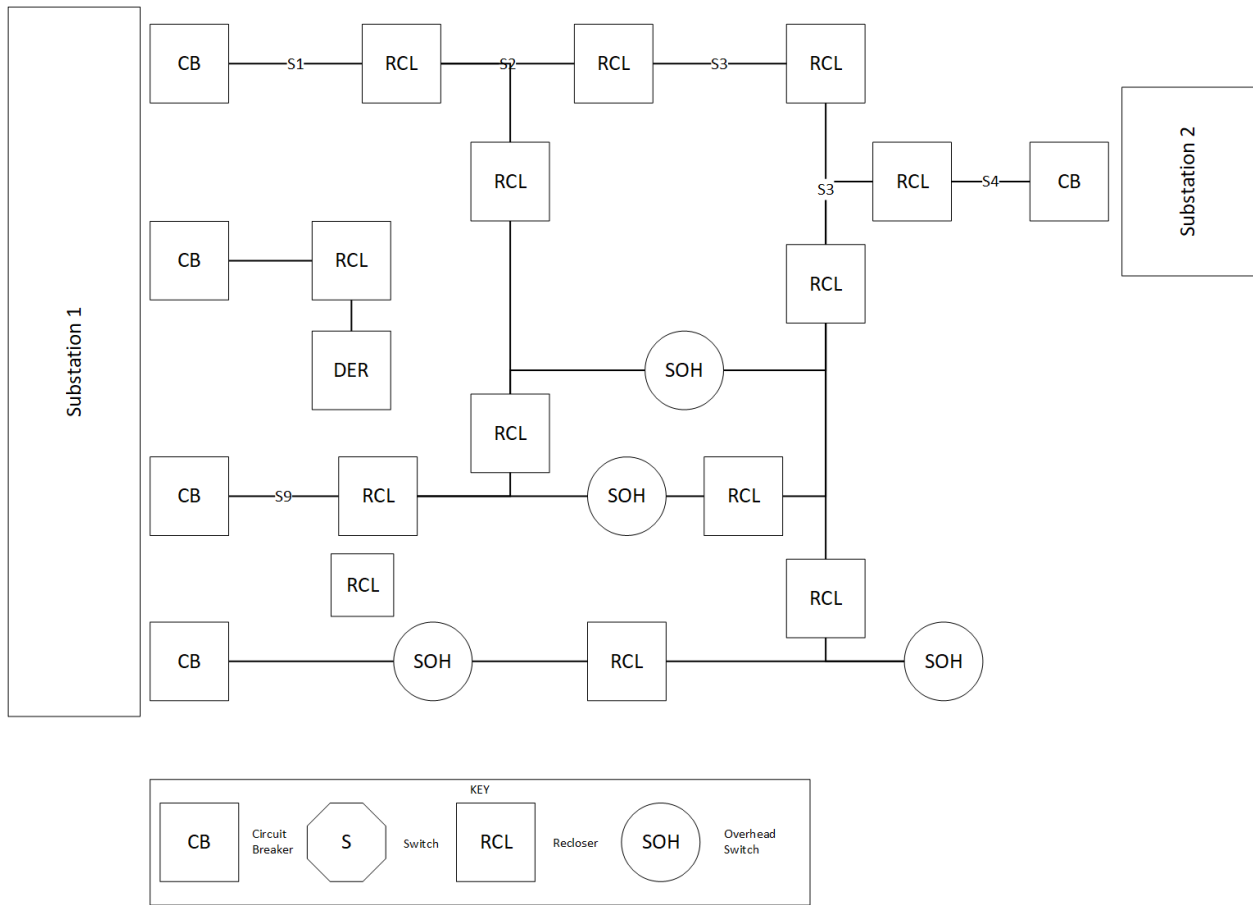

Figure 23. Meshed Distribution Feeder with High Level of DA

Basic Structural Considerations

Starting with the segments, a layered approach provides a uniform logical structure that may apply to all the possible physical configurations. For each segment, the DER interconnects in such a manner that the lowest layer of control and coordination balances power flow within the segment, meeting power flow and voltage constraints (objectives) at the segment ends. Constraints may also come from the next layer above that is coordinating across some collection of segments. This layer and the DER or DA devices (protection, switchgear, and power flow control) accommodate autonomous responses, allowing devices to adjust net load to support regulation of voltage or frequency based on measurements at their location. Figure 24 illustrates the basic control structure in the context of an entire regional grid.

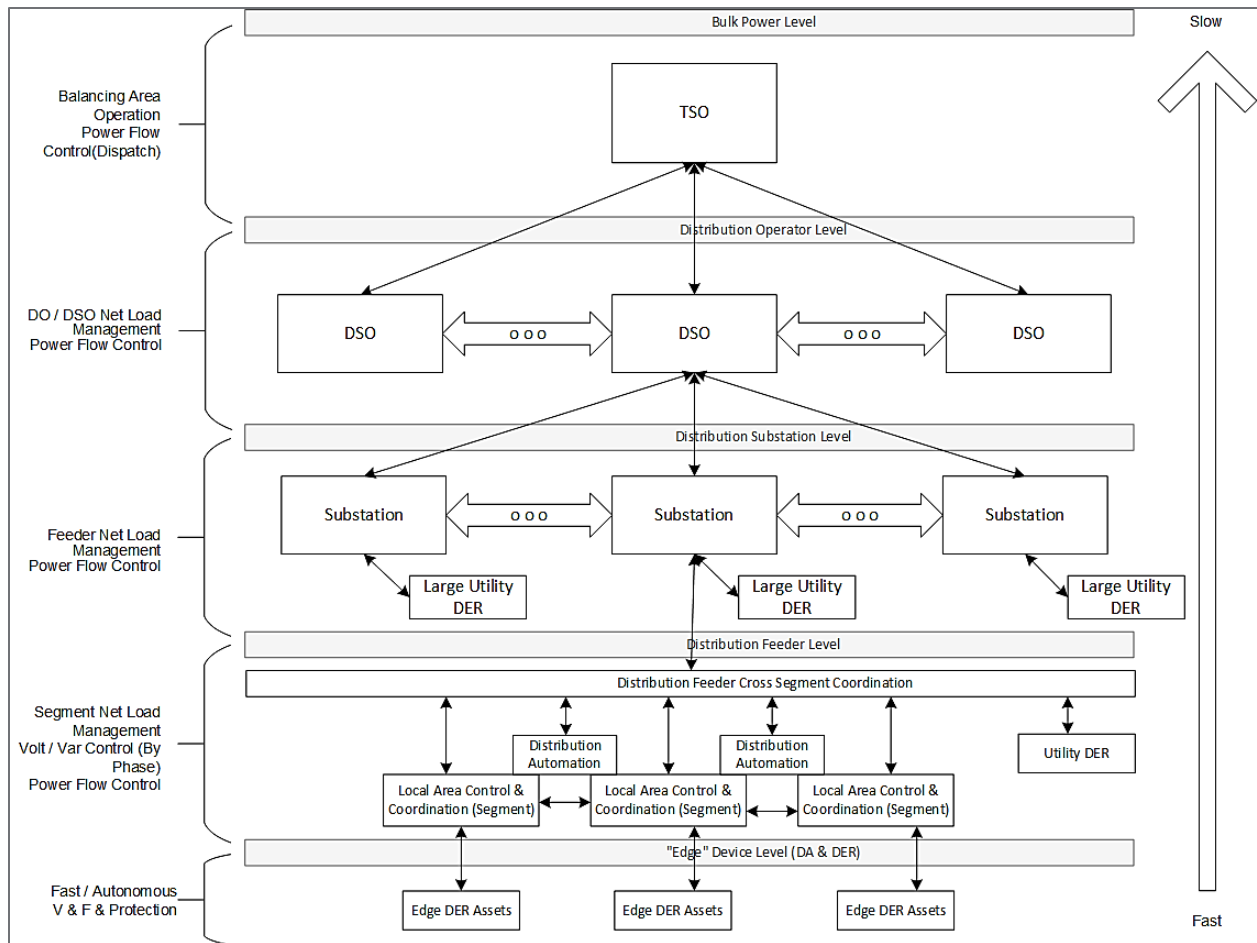

Figure 24. Basic Layered, Logical Structure for Control and Coordination of High DA/DER Feeders. “V & F” is voltage and frequency.

In Figure 24, each layer has an interface between logical, physical, and “local” coordination of DER behavior through information sharing between the DER located on that segment and in the context of constraints and objectives passed to that layer. Through local coordination, the control system can optimize voltage on that segment and coordinate power flow at the connection points to adjacent segments via objectives and constraints shared at the next level up in a manner consistent with a laminar coordination framework layered problem decomposition.

Figure 25 puts the lower layers of structure from Figure 24 into the context of LENs. The LEN provides a common structural element with a uniform interface to the layer(s) above. The LEN must be matched to the physical infrastructure of the segment with a combination of communications, sensing, and actuation interfaces for each device. Finally, note that this structure is consistent with the different control and coordination operational time scales—from fast-acting edge devices, such as automated reclosers, to processes that deal with progressively slower time scales as one moves away from the grid edge.

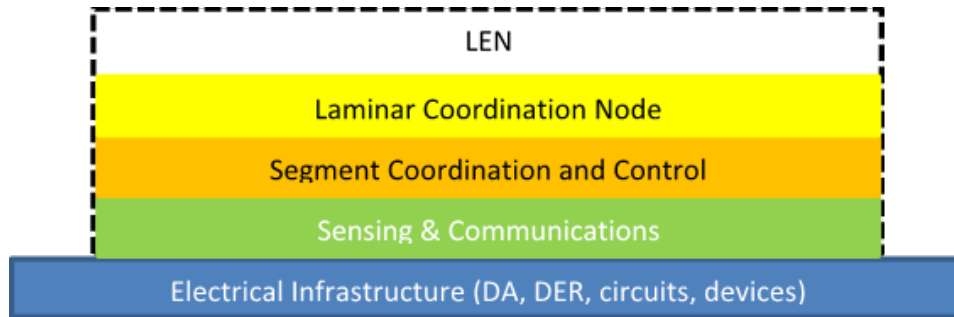

Figure 25. LEN View of Lower Layer of Laminar Coordination

The alignment with the LEN structure also puts the hierarchical structure with local segment coordination into alignment and relationship with the sensor communication structure (Figure 10), the laminar coordination domain structure (Figure 12), and the grid stack model.

Specification 10.2 details

- 10.2.1 Compose distribution system topology from distribution feeder segments as the basic structure building blocks.
- 10.2.2 Use structure for coordination and control that is consistent with the laminar coordination framework and LENs.
- 10.2.3 Plan for faster action near the edge, i.e., at the segment level, with the time frame of action slowing as one moves upward in the structure.
- 10.2.4 Accommodate DER at any level in the structure.
- 10.2.5 Provide support for segmentation of the control to handle normal failures in communications, coordination, and control, including fallback isolated operation when necessary.

3.3.10.3 Electrification of Transportation

The growth of electrified transportation carries with it several potential systemic issues that may be dealt with using grid architectural principles. Recent studies analyzing state and national-level EV infrastructure needs have estimated that substantial deployments of new EV supply equipment (EVSE, also known as charging stations) are required to meet near-term emissions goals and to support the robust use of millions of plug-in EVs (PEVs).^{27,28} Large deployments of PEVs and commensurate EVSE—for example, direct current, fast charging (DCFC) stations, which can supply tens to hundreds of kilowatts²⁹—lead to grid issues related to power quality and equipment lifetime. Additionally, while pilot studies of vehicle-to-grid and vehicle-to-building systems have demonstrated that vehicle fleets can support ancillary services and DR, such experiments have faced significant challenges with resource aggregation, logistics, control, and market integration.³⁰

²⁷ EW Wood, CL Rames, M Muratori, S Raghavan, and MW Melaina. (2017). *National Plug-In Electric Vehicle Infrastructure Analysis*. NREL/TP-5400-69031; DOE/GO-102017-5040. National Renewable Energy Laboratory, Golden, CO (United States). Available online: <https://www.nrel.gov/docs/fy17osti/69031.pdf>.

²⁸ A Bedir, N Crisostomo, J Allen, E Wood, and C Rames. 2018. *California Plug-In Electric Vehicle Infrastructure Projections: 2017-2025*. CEC-600-2018-001, California Energy Commission. Available online: <https://www.nrel.gov/docs/fy18osti/70893.pdf>.

²⁹ D Zhao and T Hong, *EV Charging Station Trend*. PowerPoint presentation, Argonne National Laboratory, May 2019.

³⁰ D Black, J MacDonald, N DeForest, and C Gehbauer, Lawrence Berkeley National Laboratory. 2017. *Los Angeles Air Force Base Vehicle-to-Grid Demonstration*. CEC-500-2018-025, California Energy Commission. Available at <https://ww2.energy.ca.gov/2018publications/CEC-500-2018-025/CEC-500-2018-025.pdf>.

Along with the many challenges, electrified transportation may also enable the integration of intermittent energy sources such as wind and solar.³¹ Conceptually, aggregations of PEVs may act as buffers that smooth the output of intermittent generation (see Specification 4).

Laminar Decomposition of Electric Vehicle Charging Infrastructure

Unstructured expansion of EVSE infrastructure may ultimately result in a vast, heterogeneous collection of charging stations with diversity of supply capability, ownership, communication capability, and spatial location and density. A structured, layered approach can be used to support load diversity, aggregation, and appropriate coordination and control of these resources. Figure 26 describes the application of conventional laminar decomposition to charging infrastructure.

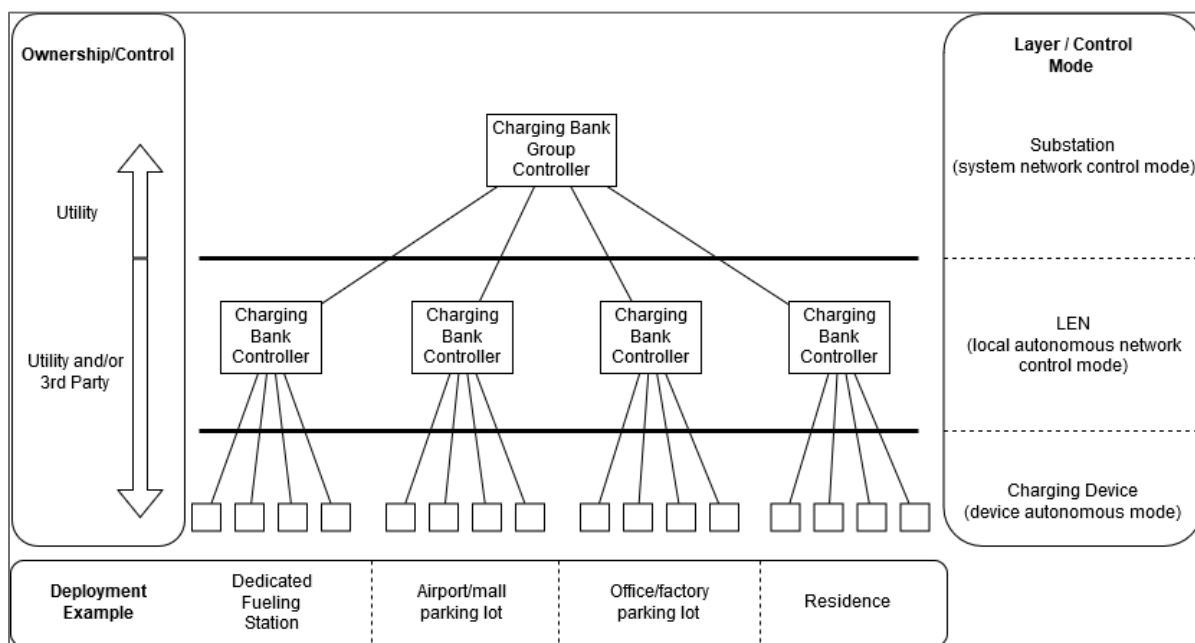

Figure 26. Laminar Decomposition of Stationary Charging Infrastructure for PEVs

Charging infrastructure comprises three hierarchical layers: charging-bank-group controllers, charging-bank controllers, and individual charging stations. Each layer corresponds to a specific ownership and control mode model. This type of structure can support load diversity, aggregation, and coordination/control in the face of unstructured deployment of heterogeneous PEV charging infrastructure.

By superimposing a layered structure onto charging stations, logical aggregations of stations and hierarchical associations of such aggregations can be formed. These aggregations, which may be dynamic in nature, map naturally to LENS. This mapping suggests that, at a minimum, charging station infrastructure can actively participate in general resilience-enhancing functions of a LEN.

With the appropriate communication structures and an adequate population of charging stations, this layered approach may also enable the coordination of a diverse set of EV resources. The concept of α -fair

³¹ T Markel, et al., *Multi-Lab EV Smart Grid Integration Requirements Study: Providing Guidance on Technology Development and Demonstration*. NREL/TP-5400-63963, National Renewable Energy Laboratory, Golden, CO (United States), 2015. Available online: <https://www.nrel.gov/docs/fy15osti/63963.pdf>.

resource allocation, described by Altman et al.,³² and originally applied to sharing of wireless network resources such as throughput and signal-to-noise ratio, may be adapted to this domain to enable fairness in allocation of charging stations and their supply capacity. Different allocation strategies may be implemented by adjusting the value of α . Similarly, concepts used in hierarchical batch job scheduling systems for high-performance computing (HPC) clusters³³ may be adapted to support charging resource allocation requirements. The core issue is that the coordination framework structure should be able to support any of these approaches, and others as well.

Dynamic Aggregation of Electric Vehicles

Recent work on multi-objective optimization algorithms for charging autonomous vehicles in DR environments takes into account existing transportation infrastructure and driving patterns.³⁴ While the practical application of these technologies is highly dependent on large infrastructure investments, intelligent and dynamic aggregation of autonomous EVs has the potential to address electricity grid needs such as response to small-scale blackouts, avoiding renewable energy curtailment, and provisioning of ancillary services to the grid.

Figure 27 describes the formation of LENSs to use EVs to mitigate renewable energy source curtailment. In this example, collections of EVs associate with LENSs as dynamically marshaled (in time and space) DERs.

³² E Altman, K Avrachenkov and A Garnaev, "Generalized α -fair resource allocation in wireless networks," *2008 47th IEEE Conference on Decision and Control*, Cancun, 2008, pp. 2414-2419. Available online: <https://ieeexplore.ieee.org/document/4738709>.

³³ H Hussain et al. 2013. "A survey on resource allocation in high performance distributed computing systems." *Parallel Comput.* 39(11) (November 2013), pp. 709-736. Available online: <https://www.sciencedirect.com/science/article/pii/S016781911300121X>.

³⁴ R Iacobucci, B McLellan, and T Tezuka. (2019). "Optimization of shared autonomous electric vehicles operations with charge scheduling and vehicle-to-grid." *Transportation Research Part C: Emerging Technologies* 100:34-52. Available online: <https://www.sciencedirect.com/science/article/pii/S0968090X18309197>.

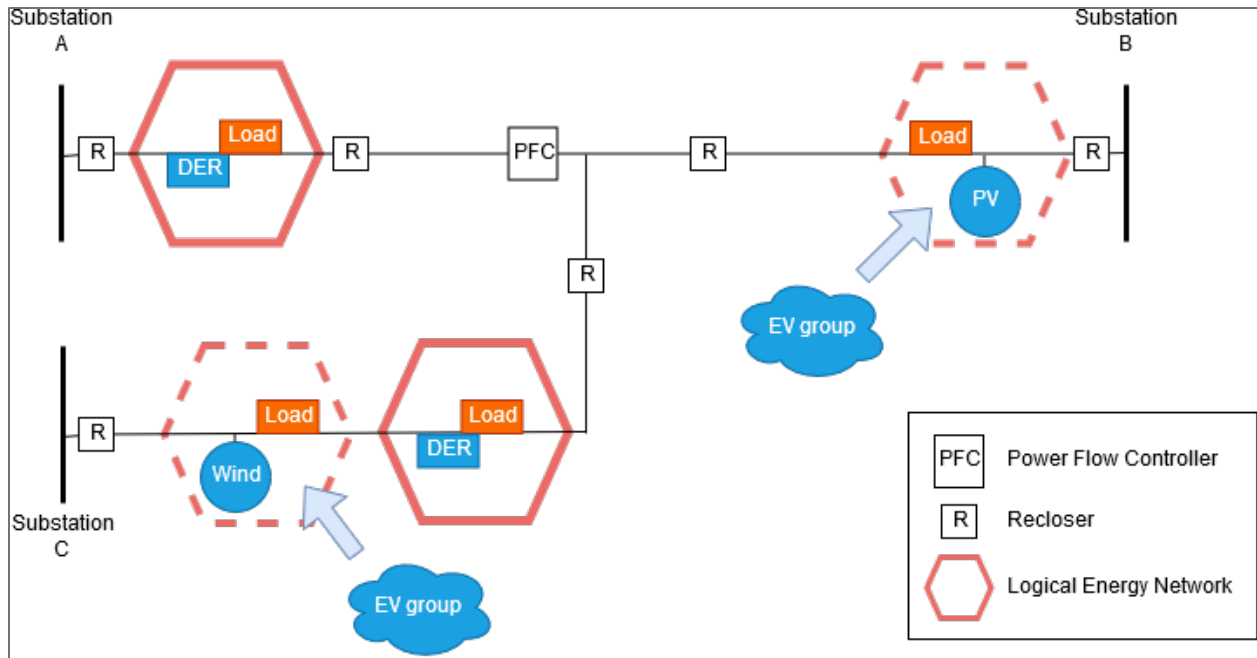

Figure 27. Autonomous EV Dynamic Groups Joining LENs to Mitigate wind/PV Curtailment

This model is not specific to groups of EVs; it may also be applied to electrified transportation that is less autonomous or less mobile. For instance, corporate vehicle fleets, mobile charging apparatus, and private collections of EVs may participate in this model. Furthermore, this model is not limited to curtailment or smoothing of renewable energy resources; it may also be applied to provision grid services such as load shifting, or to supply power during small, localized blackouts. Figure 28 outlines a layered decomposition of multiple domains that expresses both the aggregation of resources that span technology types and the interrelationships between layers. Some applications may require integration with a DO/DSO, which is not shown in Figure 28.

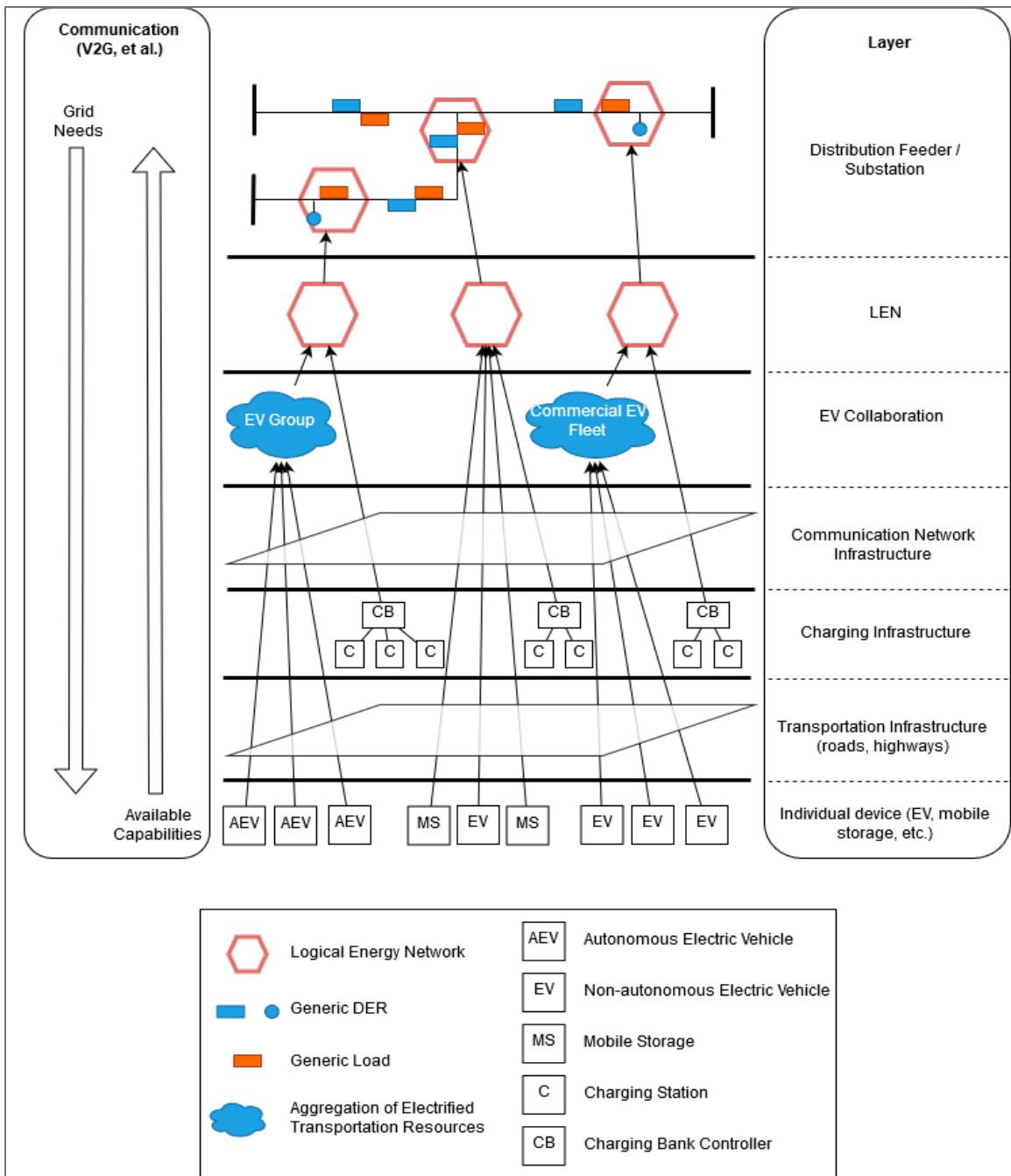

Figure 28. Layered Decomposition Applied to Synthesis of LENs and Aggregated EV Resources across Multiple Domains

Specification 10.3 details

10.3.1 Use laminar structure for organizing EV charging.

10.3.2 Recognize the effect of transportation infrastructure networks (roadways) as related to the topology of the electricity distribution system.

Where new distribution planning is being done, consider the electric hub/transportation hub model as an architectural model.³⁵

3.3.10.4 Sensing and Intelligence in Distribution Grids

Sensing and intelligence for control and fault handling (protection) at the distribution level makes use of sensor networks and distributed intelligence for grid state determination and fault analysis (detection, characterization, localization, and prediction). Sensors may be used individually or in dynamic groups via the sensor/communication layer observability platform (see Specification 3), with processing intelligence located in the distributed intelligence platform (see Specification 8). The combination of these layers allows intelligence to be located as needed throughout the distribution grid, meaning that it can reside in the control center, in substations, or in individual LENSs. Analytics and control applications may be centralized or distributed. Hosting of applications may coincide with hosting of laminar coordination nodes as per Figure 19 in Specification 5 or may reside elsewhere in the distributed intelligence platform.

FLISR actually consists of three stages: detection/characterization/localization, isolation, and service restoration. The last two are control functions and so make use of the power flow aspects of the control structure described above. The first stage is a combination of sensing, communications, and analytics. Many techniques are available for carrying out these steps, including the use of distribution level synchrophasors.³⁶ Since any particular grid observability strategy may use one or more of these methods and it may not be possible to know in advance which will be used (they may change over time), the structures support general sensor types, data flows, and processing structure models.

Specification 10.4 details

- 10.4.1 Sensing for distribution grid protection and control uses the observability platform structure and either the distributed intelligence platform structure or the laminar coordination domain structure.
- 10.4.2 Sensors may be shared across multiple protection and control applications.
- 10.4.3 Direct sensor-to-local-application data flows are permitted to provide low latency. Sensor data need not flow to a remote data store or broker first.

3.3.11 Specification 11: Communication Structures

Communications networks are key components since the electricity infrastructure is decentralized, and it has been common for electricity distribution utilities to require multiple siloed communications systems. For distributed operations, simple hub-and-spoke networks are insufficient unless Extensible Messaging and Presence Protocol (XMPP)-style relay communications are acceptable, but that approach poses single-point-of-failure issues. Generally, electric utility networks require path redundancy, and increasingly must provide low latency as well.

³⁵ JD Taft, A Shankar, et al., *Grid Architecture Specification: Urban Converged Networks Reference Architecture*, PNNL-29984, Pacific Northwest National Laboratory, May 2020. Available online at <https://gridarchitecture.pnnl.gov/library.aspx>.

³⁶ J Taft, *Fault Intelligence: Distribution Grid Fault Detection and Classification*, PNNL-27602, September 2017. Available online: https://gridarchitecture.pnnl.gov/media/white-papers/FaultIntelligence_PNNL.pdf.

Modern utility operational communications models use three primary tiers, as illustrated in Figure 29:

- wide area networks (WANs) for substation and control center communications
- field area networks (FANs) for distribution-level, multi-service, backhaul communications
- neighborhood area networks (NANs) for specific-purpose connectivity to edge devices.

The WANs are frequently optical-fiber based, with dedicated microwave links where necessary, although some hub-and-spoke, twisted-pair systems are still used. New FANs being deployed in the 2020s are fiber-based, wireless, or even a mixture of the two. The NANs are almost always wireless.

Note that the deployment of 5G (fifth generation) technology is not likely to affect utility operational communications.³⁷

³⁷ JD Taft, *The Impact of 5G Telecommunications Technology on US Grid Modernization 2017–2025*, PNNL-27068, April 2019. Available online: https://gridarchitecture.pnnl.gov/media/advanced/Communications_final_v2_GMLC.pdf.

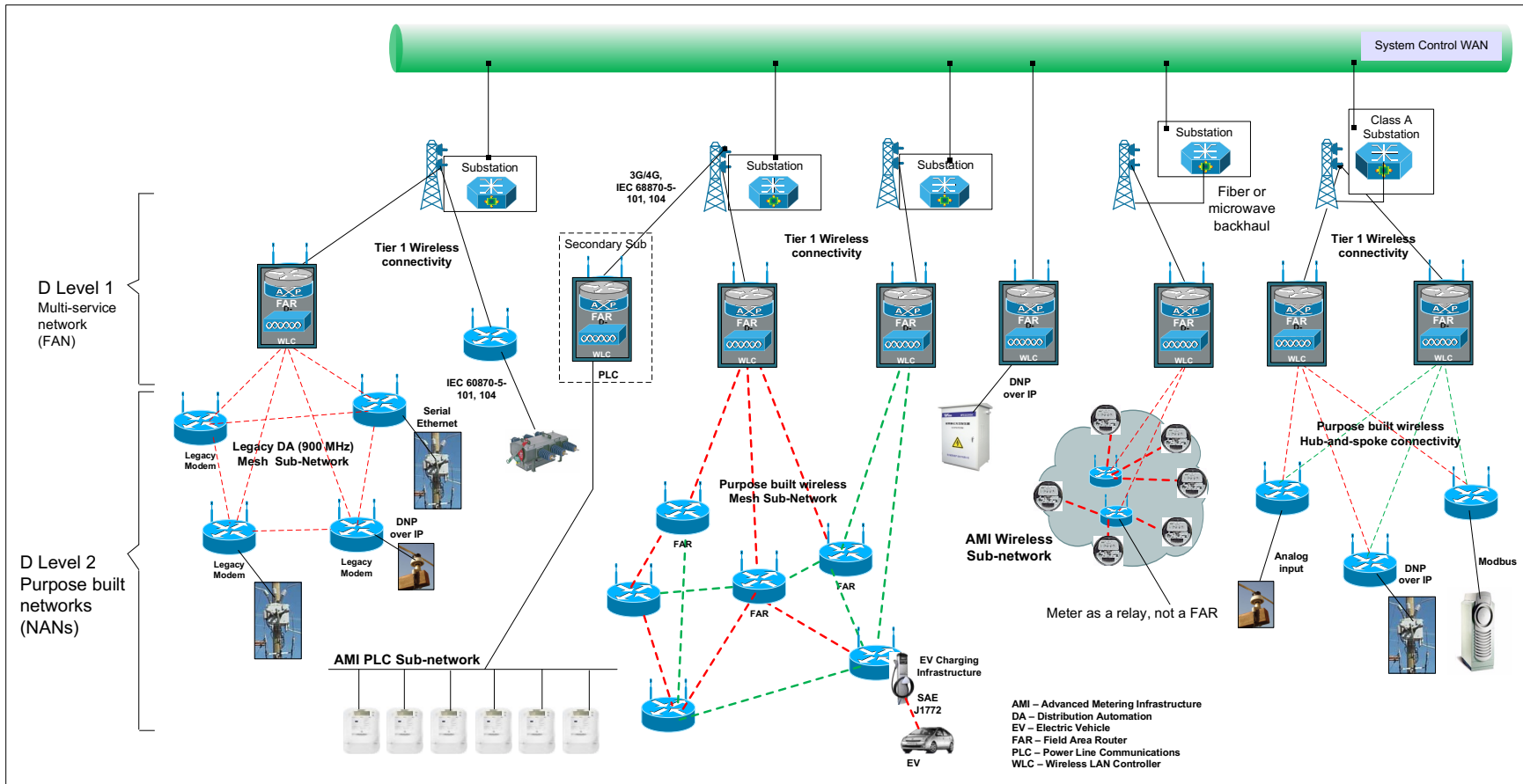

Figure 29. Three-Tier Communications Structure with Substation Aggregation

To support distributed intelligence, it is necessary to consider one additional tier: intra-substation networks. Note that in Figure 29 and **Error! Reference source not found.**, field communication is aggregated to the substations rather than connected directly to the control center in a hub-and-spoke arrangement, as has been common practice for distribution SCADA. Substation internal networks must support several functionality groups, including protection, asset management, physical security, workforce management, and NAN aggregation.³⁸

The combination of FAN and WAN can be logically organized into a layer, to be combined with sensors and the electric infrastructure, as discussed in Specification 3 and as shown in Figure 10. This supports both the distributed intelligence structure and the LAN/laminar coordination framework.

Specification 11 details

- 11.1 Use a three-tier structure: high performance WAN, multi-services FAN, and purpose-built NANs.
- 11.2 Aggregate FAN communications to substations to facilitate distributed intelligence.
- 11.2 When integrating ESO communications with the control center, allow for coordination signals to be passed from DER devices through the aggregator, to the control center, and down through the utility networks to the appropriate laminar coordination nodes. The ESO can act as the host for coordinator nodes on behalf of the devices they manage.

Integrating ESOs with laminar coordination involves the question of how to connect nonutility devices to the coordination framework. In some cases, the utility will control the devices directly, so the issue is not complex. In the case of ESOs, the solution is more complex but does illuminate a new value for the ESOs, namely completion of the laminar coordination chains and hosting coordination nodes for devices.³⁹ With the demise of the DER aggregator business model, this issue may become moot.

3.3.12 Specification 12: Data Flow Models

We use the E-R description of the primary constituents of the grid “as is” to outline the new data flow requirements. Figure 30 describes a typical existing grid structure.

³⁸ JD Taft, *Advanced Networking Paradigms for High-DER Distribution Grids*, PNNL-25475, May 2016. Available online: <https://gridarchitecture.pnnl.gov/media/advanced/Advanced%20Networking%20Paradigms%20final.pdf>.

³⁹ JD Taft, *Architectural Basis for Highly Distributed Transactive Power Grids: Frameworks, Networks, and Grid Codes*, PNNL-25480, June 2016. Available online: https://gridarchitecture.pnnl.gov/media/advanced/Architectural%20Basis%20for%20Highly%20Distributed%20Transactive%20Power%20Grids_final.pdf.

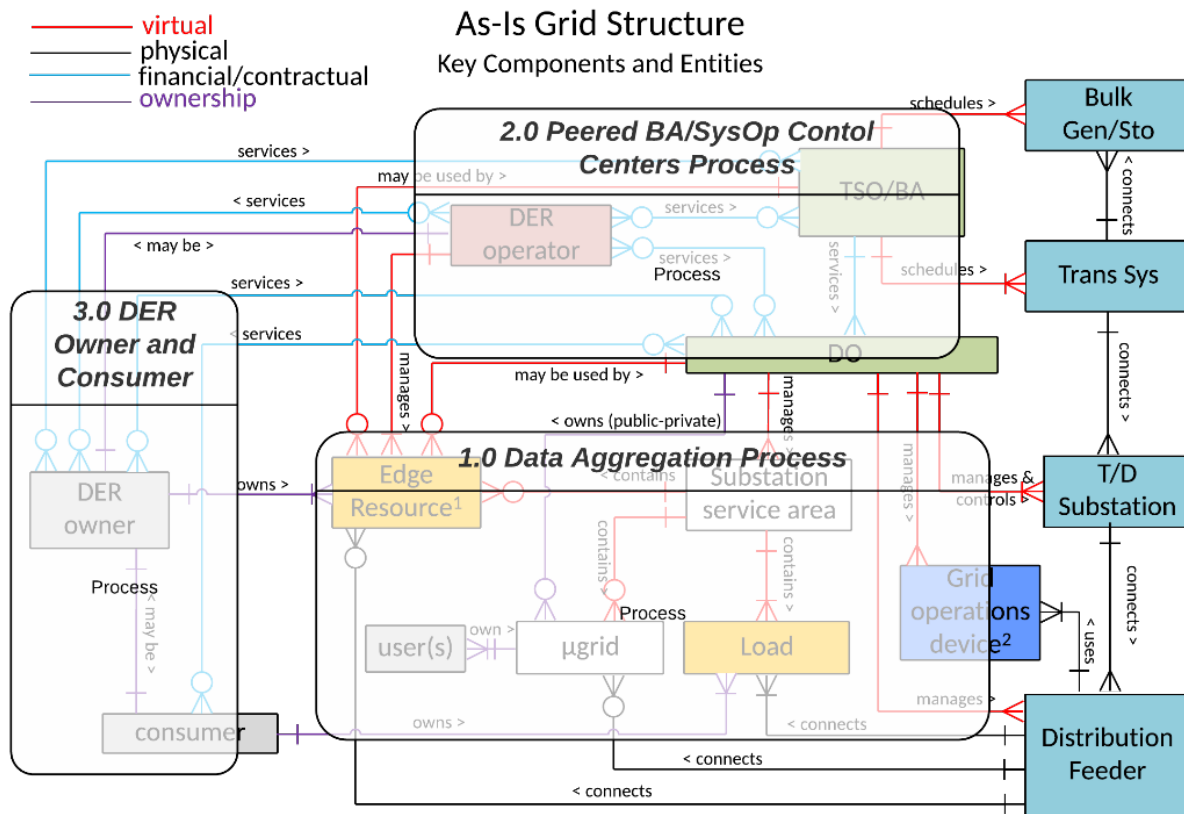

Figure 30. Data Flows Overlaid on “As Is” Grid Entities

The system divides the main data components into source data that is collected and aggregated, then transferred to the operations and control center for processing of data, and finally to the user and applications-facing data processes. The sensor source data is represented in the “1.0 Data Aggregation Process” module representing (typically minimal state) aggregated information from distributed energy and edge resources including microgrids and loads. The operations and control centers data processes are shown in the 2.0 Peered BA/Sys OP-Control Centers Process module which holds and manages the data for system state and control. This process includes data exchange with peers, storage of monitoring information in historians, and providing typically open-loop directives used in grid control processes such as automatic generation control. Finally, the system data from aggregators and operations centers may be exchanged with owners and consumer entities, which is denoted by 3.0 Operator Process and Customer Interaction that requests services and enable data exchange for purposes that include, in full generality, DR, trading, and interactions with edge services operators. Recall that this data flow architecture in present-day (“as is”) grids only supports open-loop and delayed response operations.

The following data architectural structures support multiple closed-loop feedback controls that increasingly rely on sensor measurement data that is dynamic, reliable, tolerant to partial and intermittent connectivity, and secure.

Data Architecture Considerations

Total DSO/TSO industry structure and the transmission observability platform require that DSO must have much higher visibility than existing systems into their operational data and control constructs, and

must be the energy data interface to the TSO and peers. The transmission observability platform requires a common addressable interface to data holdings across the system operator/reliability coordinator, utilities, and edge resources.

Flow control and regulation via power electronics in distribution grids requires that data flows enable periodic state-information exchange between control points in a coordinated fashion. This information is required and used for topology identification, control signal determination, and PFC connectivity to peer DERs (controlled by their own control points) and the bulk grid.

Distribution layer structure and observability platforms require a move away from siloed structures. Layers should be used to provide both redundancy (through peer-to-peer information exchange within a layer) and self-sufficiency, with enough information coverage within a single platform that encapsulates one or more layers and components to enable independent operations. The design of the data flows here requires the architecture to operate with internal consistency, but also to present a uniform set of abstractions to peers. A thematic way of describing this is through micro-services that are assembled into a single function and disassembled when operating as a distributed system. Data carrying time distribution and synchronization is required. The observability allows dynamic changes in topology, which is a condition of high DER and high storage deployments.

Laminar coordination networks rely heavily on distributed data flows that exchange periodic information that supports eventual consistency. For a resilient grid architecture, the state space of distributed control is accomplished by supporting multiple operational instantiations between fully disconnected and connected operations. (This is necessarily discrete states because the physical networks and entities do not exist in “continuous” space.) For predefined disconnected and partially (to fully) connected operations, peering data flows must communicate system state and operational heartbeat information. These require logical processes that are independent of the physical location of the infrastructure. Data flow services should make no assumption about the spatial location or context of any service.

Logical energy networks and distribution virtualization form a laminar decomposition realization for grid stress and strain contingency support and resilient operations. Enabled by distribution virtualization, a typical LEN needs to include energy sources fed by two primary distribution feeders, and a certain amount of DG/DS resources. The data flows must support local balance and grid services resource management, including Volt/VAR regulation. This operation is outlined in the LEN concept of operations document⁴⁰. As in previous data architecture configurations, peered data exchange is a critical structural construct to enable the LENs from a data systems point of view.

Individual feeders and overlaid LENs can be partitioned or segmented into multiple virtual control areas or microgrids for autonomous power balancing, as mentioned in Specification 2. Between two neighboring segments, the PFC device state data will be exchanged in the 2.0 “Peered...” block in Figure 30.

Distributed intelligence platform and communications structures require a layered platform model to store and process data from the device hardware and sensors, firmware, operating systems, and communications systems to application devices.

Figure 31 illustrates data flows derived from the above architectural considerations.

⁴⁰ LEN ConOps v0.3.pdf available within specification package at:
https://gridarchitecture.pnnl.gov/media/zip/High_DER_DA_Sto_Reference_Architecture_package.zip

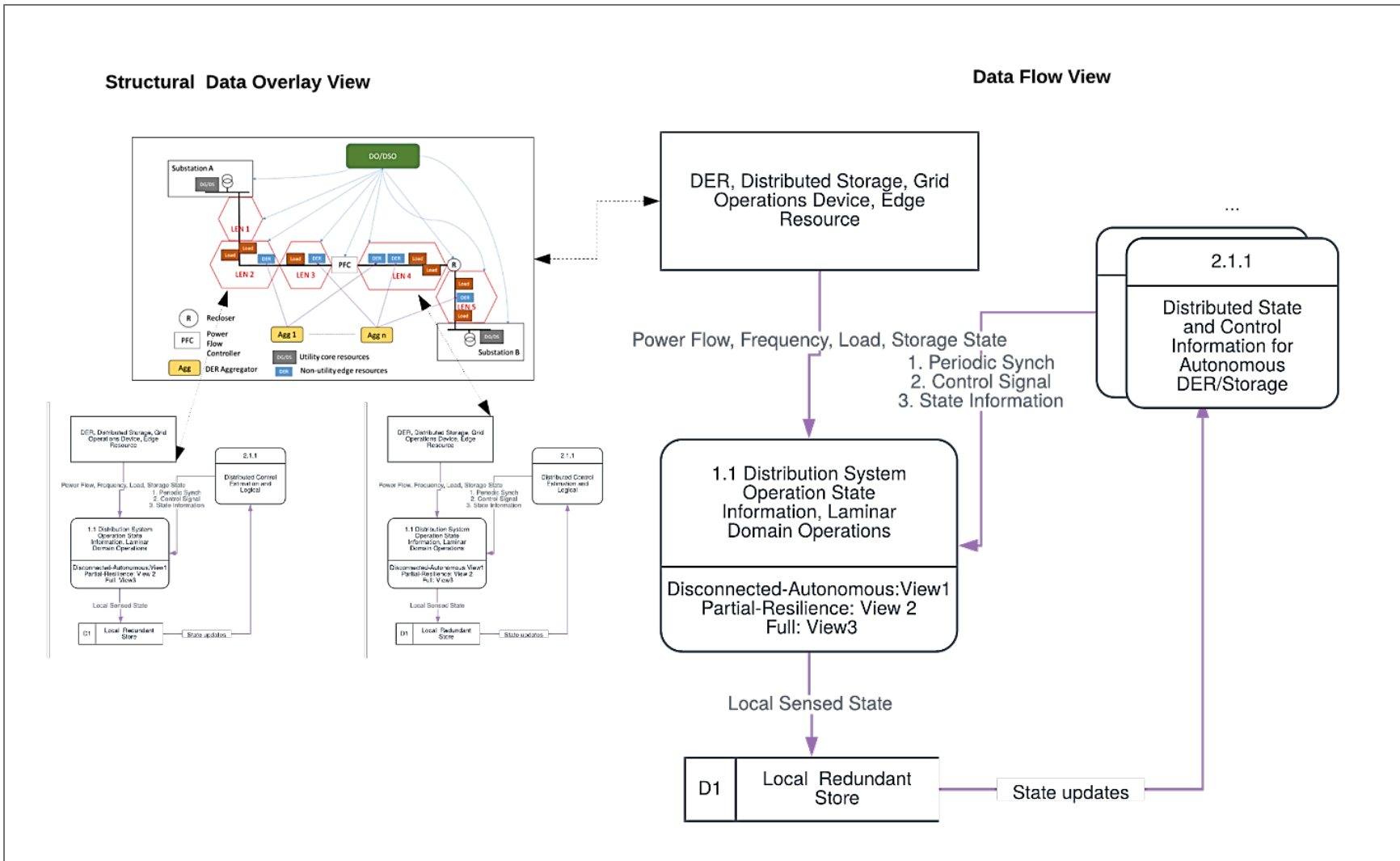

Figure 31. Data Flows for High-DER Deployments

We note the key changes from the “as is” data flows as follows. The previously shown high-level “Data Aggregation Process” module shown in Figure 30 is now shown in greater detail on the right-hand side of Figure 31. The structural correspondence of multiple (potentially autonomous) DERs and storage systems in LENS is shown on the left of Figure 31. Data is stored locally to enable the laminar domain operations. Support for disconnected and autonomous operations control is explicitly implemented. This requires computing and data middleware at the edge of the grid with built-in redundancy for data communication failures and explicit operation modes with only partial state. The operations and control centers’ data module “Peered BA/Sys OP-Control Centers Process” in Figure 30 is refined to become a LENS module and we show the sub-component that holds the data state is shown in Block 2.1.1 of Figure 31 (“Distributed State and Control Information for Autonomous DER/Storage”). This data process periodically synchronizes state with the edge-device-control laminar domains and sends feedback control signals that are derived from the state data. This module also supports a LENS distributed data-exchange function that includes aggregation and data exchange with peers, and storage of monitoring information in historians. The support of communication messages and signals that exchange topology and control information is fundamental to the degree of autonomy and peering that the edge devices are given and to when they are incorporated back into broader DSO and TSO operations.

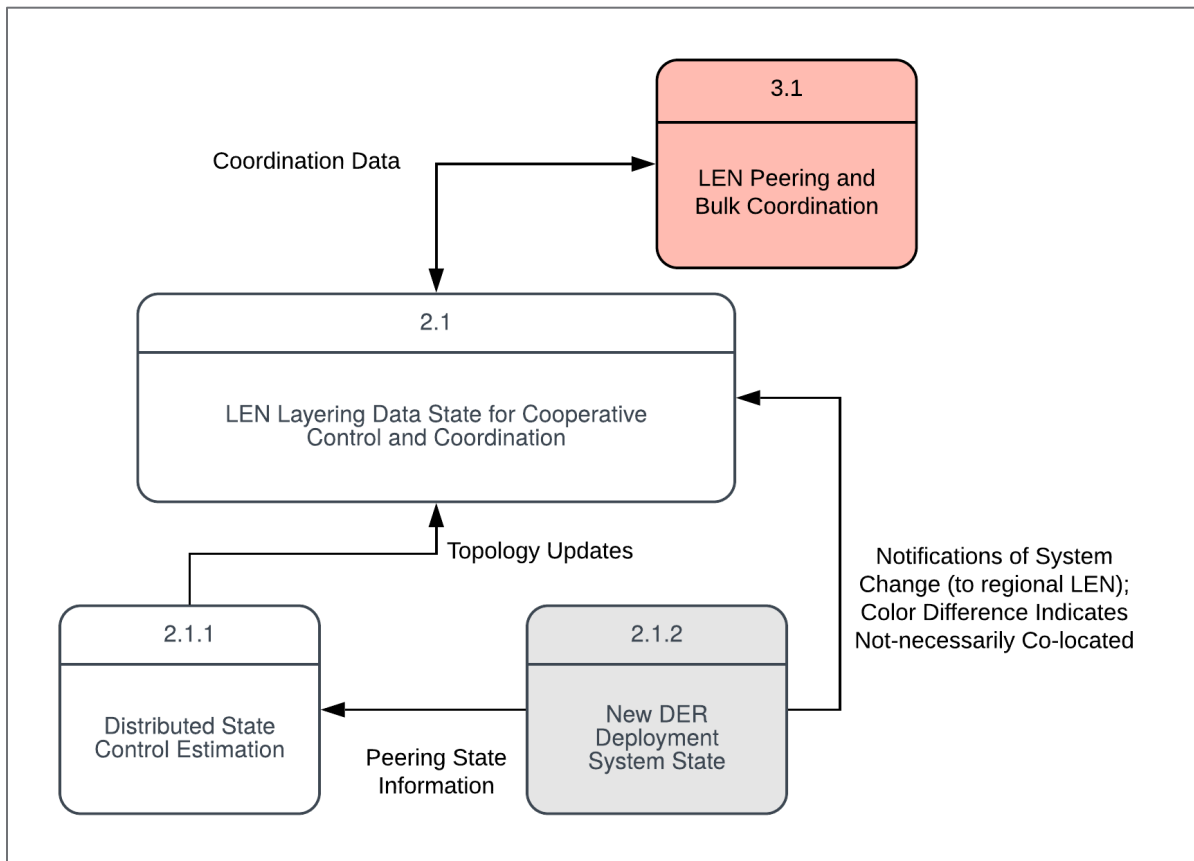

Figure 32. Coordination and Collaboration Data Flows

Figure 32 illustrates the new data flows that are required by the architectural recommendations with increasing penetrations of DERs and storage in the grid. Principled data flows must be instantiated to collect the autonomous system data from control points and these data elements (represented in Figure 32 as Data Process 2.1.1) must be exchanged with LENS control points. These LENS control points enable the coordination with peering LENSs shown in Data Process 3.1. Unique to this architecture is the high degree

of autonomy, topology change, and power heterogeneity (in control, voltage profile, etc.), which gives rise to the systemic issue of high dynamism. To address this issue, data processes must be developed to incorporate system state change (Data Process 2.1.2) and these notifications should be exchanged with the local LEN and coordination control networks that enable LENs (for DERs and storage) to connect with each other and the bulk grid.

Specification 12 details

- 12.1 Edge devices, microgrids, and DERs must retain data within an accepted resilience time window.
- 12.2 The locus of laminar coordination must store the data using established state-information gathering and control methods.
- 12.3 The data service interface must be addressable in a uniform manner. In this regard, the location for a data service for state-information retrieval must be available at the utility, DSO, and LEN levels. (This must be implemented similarly to DNS lookup and addressable IP ports.)
- 12.4 The data flows must support the same interface for flexible configuration of laminar domains within the domain and for external requests. (This is similar to service application programming interfaces (APIs) that are made available and extensible through systematic namespace management.)
- 12.5 A data flow service for eventual consistency must be implemented.
- 12.6 Data service must be available upon DER addition/removal and topology change events.
- 12.7 Data sources should submit data within required time constants for the correct implementation of distributed-control, stress-resistant, and strain-tolerance algorithms deployed in the resilient grid. Make sure that timing distribution dependences are explicit.

4.0 Composite Structure Views

The use of DERs as resilience assets leads to a grid structure in which distribution systems are virtualized into LENs coordinated via laminar networks and managed using the total DSO role set to interface with TSOs. This approach requires distributed intelligence at the distribution grid level, and it benefits from silo-to-layer conversion of sensing, communications, and control into a platform model where sensing and communications become an infrastructure layer that supports many decoupled applications. This layered model applies at both the transmission and distribution levels.

Grid E-R structure with DSO and LENs

Figure 33 shows the revised grid E-R model for a DSO/LEN structured grid (compare to Figure 1).

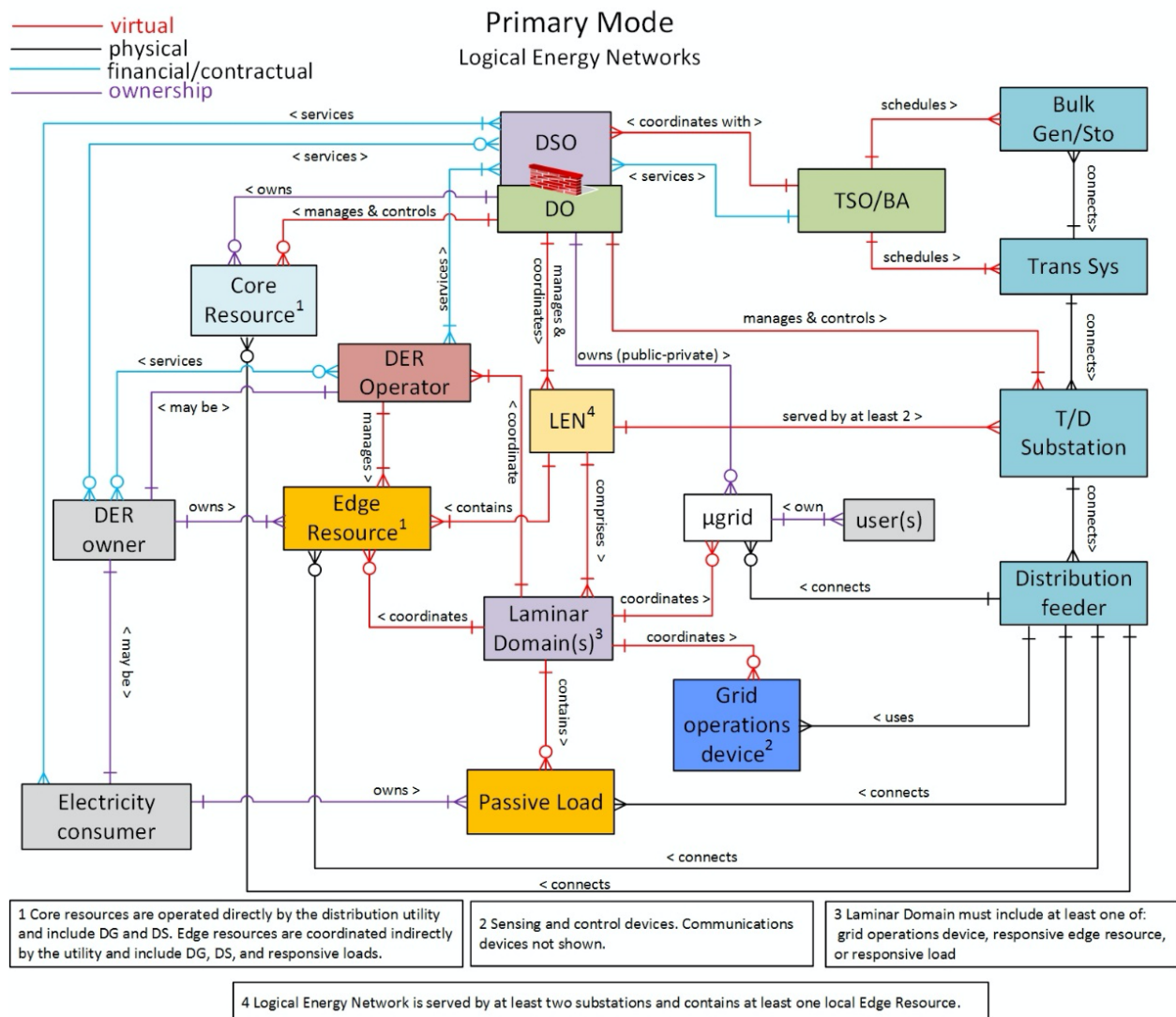

Figure 33. New LEN/Laminar/DSO-Based Grid Structure E-R Diagram

Note that distribution systems are decomposed into LENSs and laminar domains and that distribution operators may own and operate core DG and/or DS. Edge resources interface to the TSO only through the DSO. No tier bypassing occurs.

Composite Coordination/Control/Communications View

Figure 34 depicts a composite view of coordination, control, and communication that employ the structures detailed above.

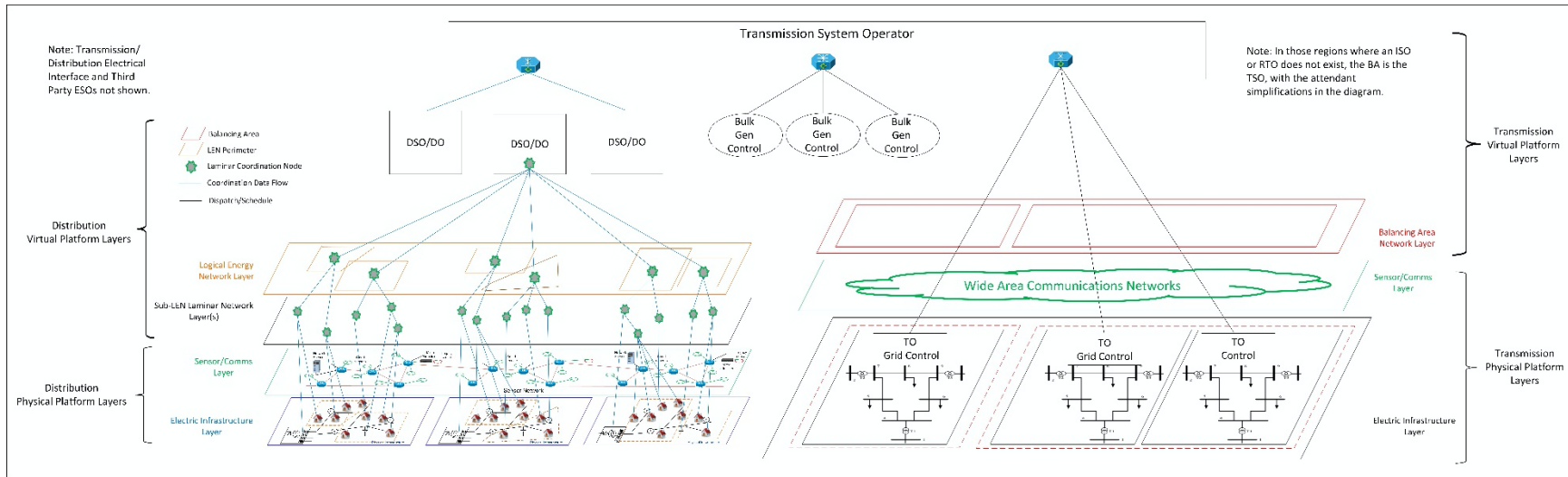

Figure 34. Composite View of Grid Structure Coordination, Control, and Communication

The DSO/LEN/laminar structure provides a regularized way to manage DER, regardless of how it is geographically dispersed, so that the TSO does not have to be limited to treating DER as if it existed at load aggregation points, and without needing detailed distribution-grid state information. The DO does not have to deal with bypassing by the TSO and can thus make sure that use of DER does not conflict with distribution-level reliability objectives. The interfaces between the TSO and DSOs are far fewer in number than the potential number of DER devices, and there is no direct communication path from edge-connected (and internet-connected) DER to the TSO.

Version History

Action	Date	Description	Author(s)
Created	11/17/2020	Originated to support FAST DERMS Architecture Specification.	JD Taft, JP Ogle
Released	04/15/2021	Initial release	JD Taft, JP Ogle



902 Battelle Boulevard
P.O. Box 999
Richland, WA 99352
1-888-375-PNNL (7665)

<http://gridmodernization.labworks.org/>